



CY7C43642
 CY7C43662
 CY7C43682

1K/4K/16K x36 x2 Bidirectional Synchronous FIFO

Features

- High-speed, low-power, bidirectional, First-In, First-Out (FIFO) memories
- 1Kx36x2 (CY7C43642)
- 4Kx36x2 (CY7C43662)
- 16Kx36x2 (CY7C43682)
- 0.35-micron CMOS for optimum speed/power
- High speed 133-MHz operation (7.5-ns read/write cycle times)
- Low power
 - $I_{CC} = 100$ mA
 - $I_{SB} = 10$ mA
- Fully asynchronous and simultaneous read and write operation permitted
- Mailbox bypass register for each FIFO
- Parallel Programmable Almost Full and Almost Empty flags
- Retransmit function
- Standard or FWFT mode user selectable
- 120-pin TQFP packaging
- Easily expandable in width and depth

Logic Block Diagram

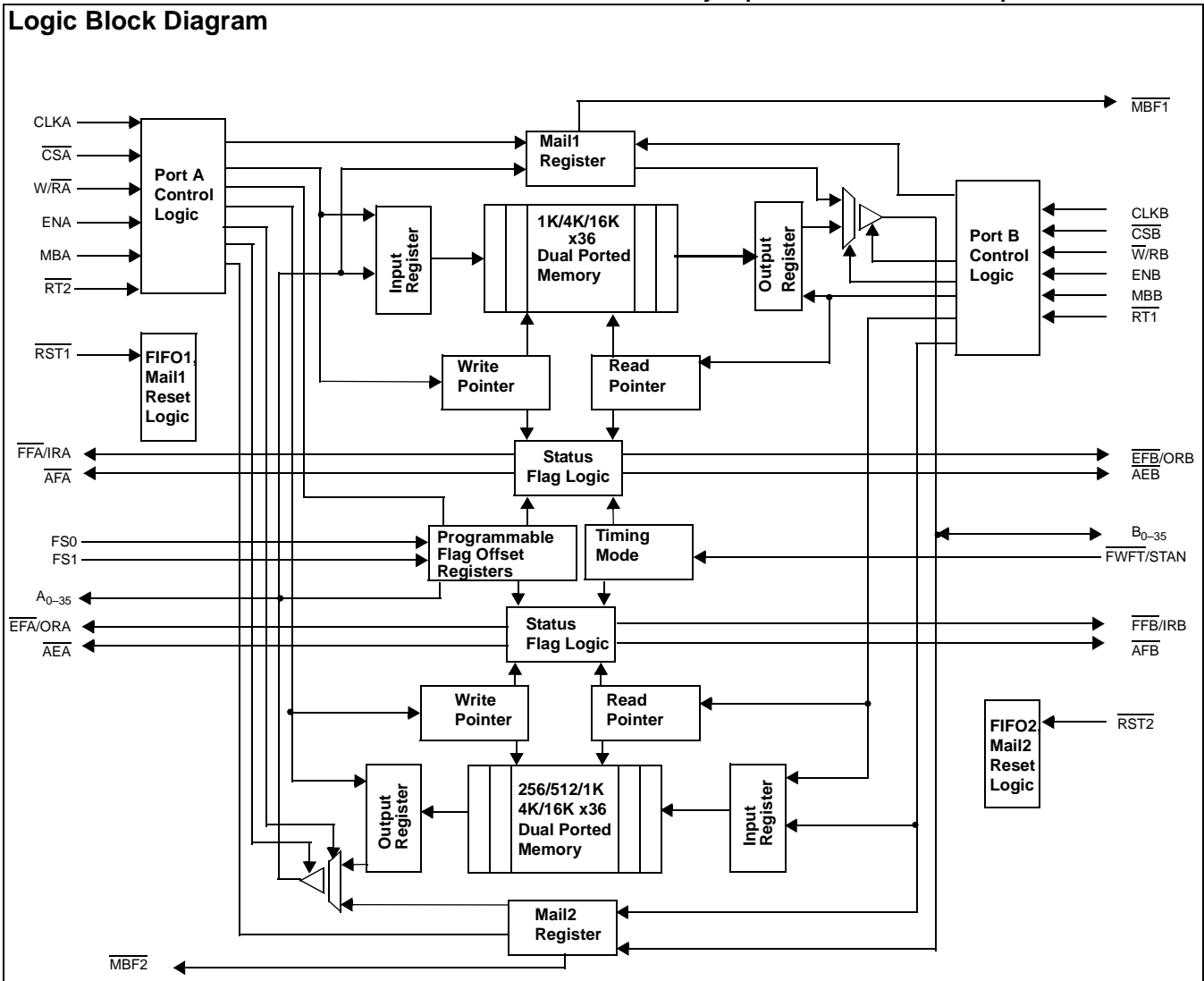

Pin Configuration

TQFP
 Top View

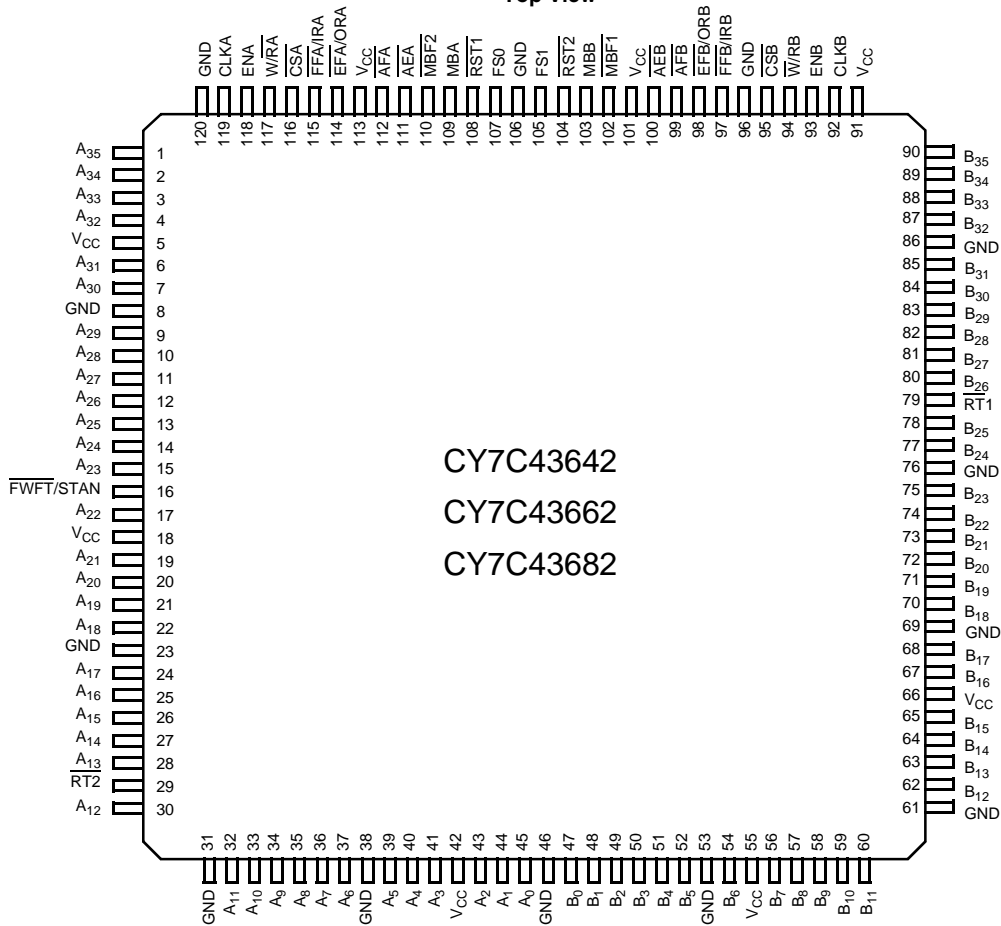



Functional Description

The CY7C436X2 is a monolithic, high-speed, low-power, CMOS Bidirectional Synchronous (clocked) FIFO memory which supports clock frequencies up to 133 MHz and has read access times as fast as 6 ns. Two independent 1K/4K/16K x 36 dual-port SRAM FIFOs on board each chip buffer data in opposite directions.

The CY7C436X2 is a synchronous (clocked) FIFO, meaning each port employs a synchronous interface. All data transfers through a port are gated to the LOW-to-HIGH transition of a port clock by enable signals. The clocks for each port are independent of one another and can be asynchronous or coincident. The enables for each port are arranged to provide a simple bidirectional interface between microprocessors and/or buses with synchronous control.

Communication between each port may bypass the FIFOs via two mailbox registers. The mailbox registers' width matches the selected Port B bus width. Each mailbox register has a flag (MBF1 and MBF2) to signal when new mail has been stored.

Master Reset initializes the read and write pointers to the first location of the memory array, and selects parallel flag programming, or one of the three possible default flag offset settings, 8, 16, or 64. Each FIFO has its own independent Master Reset pin, RST1 and RST2.

The CY7C436X2 have two modes of operation: In the CY Standard Mode, the first word written to an empty FIFO is deposited into the memory array. A read operation is required to access that word (along with all other words residing in memory). In the First-Word Fall-Through Mode (FWFT), the first word (36-bit wide) written to an empty FIFO appears automatically on the outputs, no read operation required (nevertheless, accessing subsequent words does necessitate a formal read request). The state of the FWFT/STAN pin during FIFO operation determines the mode in use.

Each FIFO has a combined Empty/Output Ready Flag (EFA/OR \bar{A} and EFB/OR \bar{B}) and a combined Full/Input Ready Flag (FFA/IR \bar{A} and FFB/IR \bar{B}). The EF and FF functions are selected in the CY Standard Mode. EF indicates whether the memory is full or not. The IR and OR functions are selected in the First-Word Fall-Through Mode. IR indicates whether or not the FIFO has available memory locations. OR shows whether the FIFO has data available for reading or not. It marks the presence of valid data on the outputs.^[1]

Each FIFO has a programmable Almost Empty flag (\overline{AEA} and \overline{AEB}) and a programmable Almost Full flag (AFA and AFB). AEA and AEB indicate when a selected number of words written to FIFO memory achieve a predetermined "almost empty state." AFA and AFB indicate when a selected number of words written to the memory achieve a predetermined "almost full state."^[2]

IR \bar{A} , IR \bar{B} , \overline{AFA} , and \overline{AFB} are synchronized to the port clock that writes data into its array. OR \bar{A} , OR \bar{B} , AEA, and AEB are synchronized to the port clock that reads data from its array. Programmable offset for \overline{AEA} , \overline{AEB} , AFA, and AFB are loaded in parallel using Port A. Three default offset settings are also provided. The AEA and AEB threshold can be set at 8, 16, or 64 locations from the empty boundary and AFA and AFB threshold can be set at 8, 16, or 64 locations from the full boundary. All these choices are made using the FS0 and FS1 inputs during Master Reset.

Two or more devices may be used in parallel to create wider data paths.

The CY7C436X2 are characterized for operation from 0°C to 70°C commercial, and from -40°C to 85°C industrial. Input ESD protection is greater than 2001V, and latch-up is prevented by the use of guard rings.

Selection Guide

		CY7C43642/62/82 -7	CY7C43642/62/82 -10	CY7C43642/62/82 -15
Maximum Frequency (MHz)		133	100	66.7
Maximum Access Time (ns)		6	8	10
Minimum Cycle Time (ns)		7.5	10	15
Minimum Data or Enable Set-up (ns)		3	4	5
Minimum Data or Enable Hold (ns)		0	0	0
Maximum Flag Delay (ns)		6	8	8
Active Power Supply Current (I _{CC1}) (mA)	Commercial	100	100	100
	Industrial			100

	CY7C43642	CY7C43662	CY7C43682
Density	1K x 36	4K x 36	16K x 36
Package	120 TQFP	120 TQFP	120 TQFP

Notes:

- When reading from the FIFO under FWFT, OR \bar{A} /OR \bar{B} signal should be included in the read logic to ensure proper operation. To read without gating the boundary flag (e.g., in bursts), use CY standard mode.
- When FIFO is operated at the almost empty/full boundary, there may be an uncertainty of up to 3 clock cycles for flag assertion and deassertion. Refer to "Designing with CY7C436xx Synchronous FIFO" application notes for more details on flag uncertainties.

Pin Definitions

Signal Name	Description	I/O	Function
A ₀₋₃₅	Port A Data	I/O	36-bit bidirectional data port for side A.
AEA	Port A Almost Empty Flag	O	Programmable Almost Empty flag synchronized to CLKA. It is LOW when the number of words in FIFO2 is less than or equal to the value in the Almost Empty A offset register, X2. ^[2]
AEB	Port B Almost Empty Flag	O	Programmable Almost Empty flag synchronized to CLKB. It is LOW when the number of words in FIFO1 is less than or equal to the value in the Almost Empty B offset register, X1. ^[2]
AFA	Port A Almost Full Flag	O	Programmable Almost Full flag synchronized to CLKA. It is LOW when the number of empty locations in FIFO1 is less than or equal to the value in the Almost Full A offset register, Y1. ^[2]
AFB	Port B Almost Full Flag	O	Programmable Almost Full flag synchronized to CLKB. It is LOW when the number of empty locations in FIFO2 is less than or equal to the value in the Almost Full B offset register, Y2. ^[2]
B ₀₋₃₅	Port B Data	I/O	36-bit bidirectional data port for side B.
FWFT/ <u>STAN</u>	Big Endian/First-Word Fall-Through Select	I	During Master Reset. A HIGH on <u>FWFT</u> selects CY Standard mode, a LOW selects First-Word Fall-Through mode. Once the timing mode has been selected, the level on <u>FWFT/STAN</u> must be static throughout device operation.
CLKA	Port A Clock	I	CLKA is a continuous clock that synchronizes all data transfers through Port A and can be asynchronous or coincident to CLKB. FFA/IRA, EFA/ORA, AFA, and AEA are all synchronized to the LOW-to-HIGH transition of CLKA.
CLKB	Port B Clock	I	CLKB is a continuous clock that synchronizes all data transfers through Port B and can be asynchronous or coincident to CLKA. FFB/IRB, EFB/ORB, AFB, and AEB are all synchronized to the LOW-to-HIGH transition of CLKB.
CSA	Port A Chip Select	I	CSA must be LOW to enable a LOW-to HIGH transition of CLKA to read or write on Port A. The A ₀₋₃₅ outputs are in the high-impedance state when CSA is HIGH.
CSB	Port B Chip Select	I	CSB must be LOW to enable a LOW-to HIGH transition of CLKB to read or write on Port B. The B ₀₋₃₅ outputs are in the high-impedance state when CSB is HIGH.
<u>EFA/ORA</u>	Port A Empty/Output Ready Flag	O	This is a dual-function pin. In the CY Standard Mode, the <u>EFA</u> function is selected. <u>EFA</u> indicates whether or not the FIFO2 memory is empty. In the FWFT mode, the ORA function is selected. ORA indicates the presence of valid data on A ₀₋₃₅ outputs, available for reading. <u>EFA/ORA</u> is synchronized to the LOW-to-HIGH transition of CLKA. ^[1]
<u>EFB/ORB</u>	Port B Empty/Output Ready Flag	O	This is a dual-function pin. In the CY Standard Mode, the <u>EFB</u> function is selected. <u>EFB</u> indicates whether or not the FIFO1 memory is empty. In the FWFT mode, the ORB function is selected. ORB indicates the presence of valid data on B ₀₋₃₅ outputs, available for reading. <u>EFB/ORB</u> is synchronized to the LOW-to-HIGH transition of CLKB. ^[1]
ENA	Port A Enable	I	ENA must be HIGH to enable a LOW-to-HIGH transition of CLKA to read or write data on Port A.
ENB	Port B Enable	I	ENB must be HIGH to enable a LOW-to-HIGH transition of CLKB to read or write data on Port B.
<u>FFA/IRA</u>	Port A Full/Input Ready Flag	O	This is a dual-function pin. In the CY Standard Mode, the <u>FFA</u> function is selected. <u>FFA</u> indicates whether or not the FIFO1 memory is full. In the FWFT mode, the IRA function is selected. IRA indicates whether or not there is space available for writing to the FIFO1 memory. FFA/IRA is synchronized to the LOW-to-HIGH transition of CLKA.
<u>FFB/IRB</u>	Port B Full/Input Ready Flag	O	This is a dual-function pin. In the CY Standard Mode, the <u>FFB</u> function is selected. <u>FFB</u> indicates whether or not the FIFO2 memory is full. In the FWFT mode, the IRB function is selected. IRB indicates whether or not there is space available for writing to the FIFO2 memory. FFB/IRB is synchronized to the LOW-to-HIGH transition of CLKB.



Pin Definitions (continued)

Signal Name	Description	I/O	Function
FS1	Flag Offset Select 1	I	The LOW-to-HIGH transition of a FIFO's reset input latches the values of FS0 and FS1. If either FS0 or FS1 is HIGH when a reset input goes HIGH, one of the three preset values (8, 16, or 64) is selected as the offset for the FIFO's Almost Full and Almost Empty flags. If both FIFOs are reset simultaneously and both FS0 and FS1 are LOW when RST1 and RST2 go HIGH, the first four writes to FIFO1 Almost Empty offsets for both FIFOs.
FS0	Flag Offset Select 0	I	
MBA	Port A Mailbox Select	I	A HIGH level on MBA chooses a mailbox register for a Port A read or write operation. When a read operation is performed on Port A, a HIGH level on MBA selects data from the Mail2 register for output and a LOW level selects FIFO2 output register data for output. When a write operation is performed on Port A, a HIGH level on MBA will write the data into Mail1 register while a LOW level will write the data into FIFO1.
MBB	Port B Mailbox Select	I	A HIGH level on MBB chooses a mailbox register for a Port B read or write operation. When a read operation is performed on Port B, a HIGH level on MBB selects data from the Mail1 register for output and a LOW level selects FIFO1 output register data for output. When a write operation is performed on Port B, a HIGH level on MBB will write the data into Mail2 register while a LOW level will write the data into FIFO2.
MBF1	Mail1 Register Flag	O	MBF1 is set LOW by a LOW-to-HIGH transition of CLKA that writes data to the Mail1 register. Writes to the Mail1 register are inhibited while MBF1 is LOW. MBF1 is set HIGH by a LOW-to-HIGH transition of CLKB when a Port B read is selected and MBB is HIGH. MBF1 is set HIGH following either a Master or Partial Reset of FIFO1.
MBF2	Mail2 Register Flag	O	MBF2 is set LOW by a LOW-to-HIGH transition of CLKB that writes data to the Mail2 register. Writes to the Mail2 register are inhibited while MBF2 is LOW. MBF2 is set HIGH by a LOW-to-HIGH transition of CLKA when a Port A read is selected and MBA is HIGH. MBF2 is set HIGH following either a Master or Partial Reset of FIFO2.
RT1	Retransmit FIFO1	I	A LOW strobe on this pin will retransmit the data on FIFO1. This is achieved by bringing the read pointer back to location zero. The user will still need to perform read operations to retransmit the data. Retransmit function applies to CY standard mode only.
RT2	Retransmit FIFO2	I	A LOW strobe on this pin will retransmit data on FIFO2. This is achieved by bringing the read pointer back to location zero. The user will still need to perform read operations to retransmit the data. Retransmit function applies to CY standard mode only.
W/RA	Port A Write/Read Select	I	A HIGH selects a write operation and a LOW selects a read operation on Port A for a LOW-to-HIGH transition of CLKA. The A ₀₋₃₅ outputs are in the HIGH impedance state when W/RA is HIGH.
W/RB	Port B Write/Read Select	I	A LOW selects a write operation and a HIGH selects a read operation on Port B for a LOW-to-HIGH transition of CLKB. The B ₀₋₃₅ outputs are in the HIGH impedance state when W/RB is LOW.
RST1	FIFO1 Master Reset	I	A LOW on this pin initializes the FIFO1 read and write pointers to the first location of memory and sets the Port B output register to all zeroes. A LOW pulse on RST1 selects the programming method (serial or parallel) and one of three programmable flag default offsets. It also configures Port A for bus size and endian arrangement. Four LOW-to-HIGH transitions of CLKA and four LOW-to-HIGH transitions of CLKB must occur while RST1 is LOW.
RST2	FIFO2 Master Reset	I	A LOW on this pin initializes the FIFO2 read and write pointers to the first location of memory and sets the Port B output register to all zeroes. A LOW pulse on RST2 selects the programming method (serial or parallel) and one of three programmable flag default offsets. It also configures Port B for bus size and endian arrangement. Four LOW-to-HIGH transitions of CLKA and four LOW-to-HIGH transitions of CLKB must occur while RST2 is LOW.

Signal Description

Reset (RST1, RST2)

Each of the two FIFO memories of the CY7C436X2 undergoes a complete reset by taking its associated Master Reset (RST1, RST2) input LOW for at least four Port A clock (CLKA) and four Port B clock (CLKB) LOW-to-HIGH transitions. The Master Reset inputs can switch asynchronously to the clocks. A

Master Reset initializes the internal read and write pointers and forces the Full/Input Ready flag (FFA/IRA, FFB/IRB) LOW, the Empty/Output Ready flag (EFA/ORR, EFB/ORB) LOW, the Almost Empty flag (AEA, AEB) LOW, and the Almost Full flag (AFA, AFB) HIGH. A Master Reset also forces the Mailbox flag (MBF1, MBF2) of the parallel mailbox register HIGH. After a Master Reset, the FIFO's Full/Input Ready flag is set HIGH after two clock cycles to begin normal operation. A Master

Reset must be performed on the FIFO after power-up, before data is written to its memory.

A LOW-to-HIGH transition on a FIFO reset ($\overline{RST1}$, $\overline{RST2}$) input latches the values of the Flag select (FS0, FS1) for choosing the Almost Full and Almost Empty offset programming method (see Almost Empty and Almost Full flag offset programming below).

First-Word Fall-Through ($\overline{FWFT/STAN}$)

After Master Reset, the FWFT select function is active, permitting a choice between two possible timing modes: CY Standard Mode or First-Word Fall-Through (FWFT) Mode. Once the Master Reset ($\overline{RST1}$, $\overline{RST2}$) input is HIGH, a HIGH on the $\overline{FWFT/STAN}$ input during the next LOW-to-HIGH transition of CLKA (for FIFO1) and CLKB (for FIFO2) will select CY Standard Mode. This mode uses the Empty Flag function (EFA, EFB) to indicate whether or not there are any words present in the FIFO memory. It uses the Full Flag function (FFA, FFB) to indicate whether or not the FIFO memory has any free space for writing. In CY Standard mode, every word read from the FIFO, including the first, must be requested using a formal read operation.

Once the Master Reset ($\overline{RST1}$, $\overline{RST2}$) input is HIGH, a LOW on the $\overline{FWFT/STAN}$ input during the next LOW-to-HIGH transition of CLKA (for FIFO1) and CLKB (for FIFO2) will select FWFT Mode. This mode uses the Output Ready function (ORA, ORB) to indicate whether or not there is valid data at the data outputs (A_{0-35} or B_{0-35}). (See footnote #1) It also uses the Input Ready function (IRA, IRB) to indicate whether or not the FIFO memory has any free space for writing. In the FWFT mode, the first word written to an empty FIFO goes directly to data outputs, no read request necessary. Subsequent words must be accessed by performing a formal read operation.

Following Master Reset, the level applied to the $\overline{FWFT/STAN}$ input to choose the desired timing mode must remain static throughout the FIFO operation.

Programming the Almost Empty and Almost Full Flags

Four registers in the CY7C436X2 are used to hold the offset values for the Almost Empty and Almost Full flags. The Port B Almost Empty flag (AEB) offset register is labeled X1 and the Port A Almost Empty flag (AEA) offset register is labeled X2. The Port A Almost Full flag (AFA) offset register is labeled Y1 and the Port B Almost Full flag (AFB) offset register is labeled Y2. The index of each register name corresponds with preset values during the reset of a FIFO, programmed in parallel using the FIFO's Port A data inputs (see Table 1).

To program the X1, X2, Y1, and Y2 registers from Port A, perform a Master Reset on both FIFOs simultaneously with FS0 and FS1 LOW during the LOW-to-HIGH transition of RST1 and RST2. After this reset is complete, the first four writes to FIFO1 do not store data in RAM but load the offset registers in the order Y1, X1, Y2, X2. The Port A data inputs used by the offset registers are (A_{0-9}), (A_{0-11}), or (A_{0-13}), for the CY7C436X2, respectively. The highest numbered input is used as the most significant bit of the binary number in each case. Valid programming values for the registers range from 0 to 1023 for the CY7C43642; 0 to 4095 for the CY7C43662; 0 to 16383 for the CY7C43682. (See footnote #2) After all the offset registers are programmed from Port A, the Port B Full/Input Ready (FFB/IRB) is set HIGH and both FIFOs begin normal operation.

FS0 and FS1 function the same way in both CY Standard and FWFT modes.

FIFO Write/Read Operation

The state of the Port A data (A_{0-35}) lines is controlled by Port A Chip Select (CSA) and Port A Write/Read Select (W/RA). The A_{0-35} lines are in the high-impedance state when either CSA or W/RA is HIGH. The A_{0-35} lines are active outputs when both CSA and W/RA are LOW.

Data is loaded into FIFO1 from the A_{0-35} inputs on a LOW-to-HIGH transition of CLKA when CSA is LOW, W/RA is HIGH, ENA is HIGH, MBA is LOW, and FFA/IRA is HIGH. Data is read from FIFO2 to the A_{0-35} outputs by a LOW-to-HIGH transition of CLKA when CSA is LOW, W/RA is LOW, ENA is HIGH, MBA is LOW, and EFA/ORA is HIGH (see Table 2). FIFO reads and writes on Port A are independent of any concurrent Port B operation.

The Port B control signals are identical to those of Port A with the exception that the Port B Write/Read select (W/RB) is the inverse of the Port A Write/Read Select (W/RA). The state of the Port B data (B_{0-35}) lines is controlled by the Port B Chip Select (CSB) and Port B Write/Read Select (W/RB). The B_{0-35} lines are in the high-impedance state when either CSB is HIGH or W/RB is LOW. The B_{0-35} lines are active outputs when CSB is LOW and W/RB is HIGH.

Data is loaded into FIFO2 from the B_{0-35} inputs on a LOW-to-HIGH transition of CLKB when CSB is LOW, W/RB is LOW, ENB is HIGH, MBB is LOW, and FFB/IRB is HIGH. Data is read from FIFO1 to the B_{0-35} outputs by a LOW-to-HIGH transition of CLKB when CSB is LOW, W/RB is HIGH, ENB is HIGH, MBB is LOW, and EFB/ORB is HIGH (see Table 3). FIFO reads and writes on Port B are independent of any concurrent Port A operation.

The set-up and hold time constraints to the port clocks for the port Chip Selects and Write/Read Selects are only for enabling write and read operations and are not related to high-impedance control of the data outputs. If a port enable is LOW during a clock cycle, the port's Chip Select and Write/Read select may change states during the set-up and hold time window of the cycle.

When operating the FIFO in FWFT Mode and the Output Ready flag is LOW, the next word written is automatically sent to the FIFO's output register by the LOW-to-HIGH transition of the port clock that sets the Output Ready flag HIGH, data residing in the FIFO's memory array is clocked to the output register only when a read is selected using the port's Chip Select, Write/Read Select, Enable, and Mailbox select.

When operating the FIFO in CY Standard Mode, regardless of whether the Empty Flag is LOW or HIGH, data residing in the FIFO's memory array is clocked to the output register only when a read is selected using the port's Chip Select, Write/Read Select, Enable, and Mailbox Select.

Synchronized FIFO Flags

Each FIFO is synchronized to its port clock through at least two flip-flop stages. This is done to improve flag-signal reliability by reducing the probability of the metastable events when CLKA and CLKB operate asynchronously to one another. EFA/ORA, AEA, FFA/IRA, and AFA are synchronized to CLKA. EFB/ORB, AEB, FFB/IRB, and AFB are synchronized to CLKB. Table 4 and Table 5 show the relationship of each port flag to FIFO1 and FIFO2.

Empty/Output Ready Flags ($\overline{\text{EFA}}/\text{ORA}$, $\overline{\text{EFB}}/\text{ORB}$)

These are dual-purpose flags. In the FWFT Mode, the Output Ready (ORA, ORB) function is selected. When the Output-Ready flag is HIGH, new data is present in the FIFO output register. When the Output Ready flag is LOW, the previous data word is present in the FIFO output register and attempted FIFO reads are ignored. (See footnote #1)

In the CY Standard Mode, the Empty Flag ($\overline{\text{EFA}}$, $\overline{\text{EFB}}$) function is selected. When the Empty Flag is HIGH, data is available in the FIFO's RAM memory for reading to the output register. When the Empty Flag is LOW, the previous data word is present in the FIFO output register and attempted FIFO reads are ignored.

The Empty/Output Ready flag of a FIFO is synchronized to the port clock that reads data from its array. For both the FWFT and CY Standard modes, the FIFO read pointer is incremented each time a new word is clocked to its output register. The state machine that controls an Output Ready flag monitors a write pointer and read pointer comparator that indicates when the FIFO SRAM status is empty, or empty+1.

In FWFT Mode, from the time a word is written to a FIFO, it can be shifted to the FIFO output register in a minimum of three cycles of the Output Ready flag synchronizing clock. Therefore, an Output Ready flag is LOW if a word in memory is the next data to be sent to the FIFO output register and three cycles have not elapsed since the time the word was written. The Output Ready flag of the FIFO remains LOW until the third LOW-to-HIGH transition of the synchronizing clock occurs, simultaneously forcing the Output Ready flag HIGH and shifting the word to the FIFO output register.

In the CY Standard Mode, from the time a word is written to a FIFO, the Empty flag will indicate the presence of data available for reading in a minimum of two cycles of the Empty flag synchronizing clock. Therefore, an Empty Flag is LOW if a word in memory is the next data to be sent to the FIFO output register and two cycles have not elapsed since the time the word was written. The Empty flag of the FIFO remains LOW until the second LOW-to-HIGH transition of the synchronizing clock occurs, forcing the Empty flag HIGH; only then can data be read.

A LOW-to-HIGH transition on an Empty/Output Ready flag synchronizing clock begins the first synchronization cycle of a write if the clock transition occurs at time t_{SKEW1} or greater after the write. Otherwise, the subsequent clock cycle can be the first synchronization cycle.

Full/Input Ready Flags ($\overline{\text{FFA}}/\text{IRA}$, $\overline{\text{FFB}}/\text{IRB}$)

This is a dual-purpose flag. In FWFT Mode, the Input Ready (IRA and IRB) function is selected. In CY Standard Mode, the Full Flag ($\overline{\text{FFA}}$ and $\overline{\text{FFB}}$) function is selected. For both timing modes, when the Full/Input Ready flag is HIGH, a memory location is free in the SRAM to receive new data. No memory locations are free when the Full/Input Ready flag is LOW and attempted writes to the FIFO are ignored.

The Full/Input Ready flag of a FIFO is synchronized to the port clock that writes data to its array. For both FWFT and CY Standard modes, each time a word is written to a FIFO, its write pointer is incremented. The state machine that controls a Full/Input Ready flag monitors a write pointer and read pointer comparator that indicates when the FIFO SRAM status is full, or full-1. From the time a word is read from a FIFO, its previous memory location is ready to be written to in a

minimum of two cycles of the Full/Input Ready flag synchronizing clock. Therefore, an Full/Input Ready flag is LOW if less than two cycles of the Full/Input Ready flag synchronizing clock have elapsed since the next memory write location has been read. The second LOW-to-HIGH transition on the Full/Input Ready flag synchronizing clock after the read sets the Full/Input Ready flag HIGH.

A LOW-to-HIGH transition on a Full/Input Ready flag synchronizing clock begins the first synchronization cycle of a read if the clock transition occurs at time t_{SKEW1} or greater after the read. Otherwise, the subsequent clock cycle can be the first synchronization cycle.

Almost Empty Flags ($\overline{\text{AEA}}$, $\overline{\text{AEB}}$)

The Almost Empty flag of a FIFO is synchronized to the port clock that reads data from its array. The state machine that controls an Almost Empty flag monitors a write pointer and read pointer comparator that indicates when the FIFO SRAM status is almost empty, or almost empty+1. The Almost Empty state is defined by the contents of register X1 for AEB and register X2 for AEA. These registers are loaded with preset values during a FIFO reset, programmed from Port A, or programmed serially (see Almost Empty flag and Almost Full flag offset programming above). An Almost Empty flag is LOW when its FIFO contains X or less words and is HIGH when its FIFO contains (X+1) or more words.^[2]

Two LOW-to-HIGH transitions of the Almost Empty flag synchronizing clock are required after a FIFO write for its Almost Empty flag to reflect the new level of fill. Therefore, the Almost Full flag of a FIFO containing (X+1) or more words remains LOW if two cycles of its synchronizing clock have not elapsed since the write that filled the memory to the (X+1) level. An Almost Empty flag is set HIGH by the second LOW-to-HIGH transition of its synchronizing clock after the FIFO write that fills memory to the (X+1) level. A LOW-to-HIGH transition of an Almost Empty flag synchronizing clock begins the first synchronization cycle if it occurs at time t_{SKEW2} or greater after the write that fills the FIFO to (X+1) words. Otherwise, the subsequent synchronizing clock cycle may be the first synchronization cycle.

Almost Full Flags ($\overline{\text{AFA}}$, $\overline{\text{AFB}}$)

The Almost Full flag of a FIFO is synchronized to the port clock that writes data to its array. The state machine that controls an Almost Full flag monitors a write pointer and read pointer comparator that indicates when the FIFO SRAM status is almost full, or almost full-1. The Almost Full state is defined by the contents of register Y1 for AFA and register Y2 for AFB. These registers are loaded with preset values during a FIFO reset, programmed from Port A, or programmed serially (see Almost Empty flag and Almost Full flag offset programming above). An Almost Full flag is LOW when the number of words in its FIFO is greater than or equal to (1024-Y), (4096-Y), or (16384-Y) for the CY7C436X2 respectively. An Almost Full flag is HIGH when the number of words in its FIFO is less than or equal to [1024-(Y+1)], [4096-(Y+1)], or [16384-(Y+1)], for the CY7C436X2 respectively. (See footnote #2)

Two LOW-to-HIGH transitions of the Almost Full flag synchronizing clock are required after a FIFO read for its Almost Full flag to reflect the new level of fill. Therefore, the Almost Full flag of a FIFO containing [1024/4096/16384-(Y+1)] or less words remains LOW if two cycles of its synchronizing clock have not elapsed since the read that reduced the number of

words in memory to $[1024/4096/16384-(Y+1)]$. An Almost Full flag is set HIGH by the second LOW-to-HIGH transition of its synchronizing clock after the FIFO read that reduces the number of words in memory to $[1024/4096/16384-(Y+1)]$. A LOW-to-HIGH transition of an Almost Full flag synchronizing clock begins the first synchronization cycle if it occurs at time t_{SKEW2} or greater after the read that reduces the number of words in memory to $[1024/4096/16384-(Y+1)]$. Otherwise, the subsequent synchronizing clock cycle may be the first synchronization cycle.

Mailbox Registers

Each FIFO has a 36-bit bypass register to pass command and control information between Port A and Port B without putting it in queue. The Mailbox Select (MBA, MBB) inputs choose between a mail register and a FIFO for a port data transfer operation. The usable width of both the Mail1 and Mail2 registers matches the selected bus size for Port B.

A LOW-to-HIGH transition on CLKA writes A_{0-35} data to the Mail1 Register when a Port A write is selected by CSA, W/RA, and ENA with MBA HIGH. If the selected Port A bus size is also 36 bits, then the usable width of the Mail1 Register employs data lines A_{0-35} . If the selected Port A bus size is 18 bits, then the usable width of the Mail1 Register employs data lines A_{0-17} . (In this case, A_{18-35} are don't care inputs.) If the selected Port A bus size is 9 bits, then the usable width of the Mail1 Register employs data lines A_{0-8} . (In this case, A_{9-35} are don't care inputs.)

A LOW-to-HIGH transition on CLKB writes B_{0-35} data to the Mail2 Register when a Port B write is selected by CSB, W/RB, and ENB with MBB HIGH. If the selected Port B bus size is also 36 bits, then the usable width of the Mail2 Register employs data lines B_{0-35} . If the selected Port B bus size is 18 bits, then the usable width of the Mail2 Register employs data lines B_{0-17} . (In this case, B_{18-35} are don't care inputs.) If the selected Port B bus size is 9 bits, then the usable width of the Mail2 Register employs data lines B_{0-8} . (In this case, B_{9-35} are don't care inputs.)

Writing data to a mail register sets its corresponding flag (MBF1 or MBF2) LOW. Attempted writes to a mail register are ignored while the mail flag is LOW.

When data outputs of a port are active, the data on the bus comes from the FIFO output register when the port Mailbox Select input is LOW and from the mail register when the port Mailbox Select input is HIGH.

The Mail1 Register flag ($\overline{MBF1}$) is set HIGH by a LOW-to-HIGH transition on CLKB when a Port B read is selected by CSB, W/RB, and ENB with MBB HIGH. For a 36-bit bus size, 36 bits of mailbox data are placed on B_{0-35} . For an 18-bit bus size, 18 bits of mailbox data are placed on B_{0-17} . (In this case, B_{18-35} are indeterminate.) For a 9-bit bus size, 9 bits of mailbox data are placed on B_{0-8} . (In this case, B_{9-35} are indeterminate.)

The Mail2 Register flag ($\overline{MBF2}$) is set HIGH by a LOW-to-HIGH transition on CLKA when a Port A read is selected by CSA, W/RA, and ENA with MBA HIGH.

For a 36-bit bus size, 36 bits of mailbox data are placed on A_{0-35} . For an 18-bit bus size, 18 bits of mailbox data are placed on A_{0-17} . (In this case, A_{18-35} are indeterminate.) For a 9-bit bus size, 9 bits of mailbox data are placed on A_{0-8} . (In this case, A_{9-35} are indeterminate.)

The data in a mail register remains intact after it is read and changes only when new data is written to the register. The Endian Select feature has no effect on the mailbox data.

Retransmit ($\overline{RT1}$, $\overline{RT2}$)

The retransmit feature is beneficial when transferring packets of data. It enables the receipt of data to be acknowledged by the receiver and retransmitted if necessary. Retransmit function applies to CY standard mode only.

The number of 36-/18-/9-bit words written into the FIFO should be less than full depth minus 2/4/8 words between the reset of the FIFO (master or partial) and Retransmit setup. A LOW pulse on $\overline{RT1}$, ($\overline{RT2}$) resets the internal read pointer to the first physical location of the FIFO. CLKA and CLKB may be free running but ENB (ENA) must be deasserted during and t_{RTR} after the retransmit pulse. With every valid read cycle after retransmit, previously accessed data is read and the read pointer is incremented until it is equal to the write pointer. Flags are governed by the relative locations of the read and write pointers and are updated during a retransmit cycle. Data written to the FIFO after activation of $\overline{RT1}$, ($\overline{RT2}$) are transmitted also.

Table 1. Flag Programming[2]

FS1	FS0	$\overline{RST1}$	$\overline{RST2}$	X1 and Y1 Registers ^[3]	X2 and Y2 Registers ^[4]
H	H	↑	X	64	X
H	H	X	↑	X	64
H	L	↑	X	16	X
H	L	X	↑	X	16
L	H	↑	X	8	X
L	H	X	↑	X	8
L	L	↑	↑	Programming via Port A	Programming via Port A

Table 2. Port A Enable Function

CSA	W/RA	ENA	MBA	CLKA	A_{0-35} Outputs	Port Function
H	X	X	X	X	In high-impedance state	None
L	H	L	X	X	In high-impedance state	None

Table 2. Port A Enable Function (continued)

L	H	H	L	↑	In high-impedance state	FIFO1 write
L	H	H	H	↑	In high-impedance state	Mail1 write
L	L	L	L	X	Active, FIFO2 output register	None
L	L	H	L	↑	Active, FIFO2 output register	FIFO2 read
L	L	L	H	X	Active, Mail2 register	None
L	L	H	H	↑	Active, Mail2 register	Mail2 read (set $\overline{\text{MBF2}}$ HIGH)

Table 3. Port B Enable Function

$\overline{\text{CSB}}$	$\overline{\text{W/RB}}$	$\overline{\text{ENB}}$	$\overline{\text{MBB}}$	$\overline{\text{CLKB}}$	B_{0-35} Outputs	Port Function
H	X	X	X	X	In high-impedance state	None
L	L	L	X	X	In high-impedance state	None
L	L	H	L	↑	In high-impedance state	FIFO2 write
L	L	H	H	↑	In high-impedance state	Mail2 write
L	H	L	L	X	Active, FIFO1 output register	None
L	H	H	L	↑	Active, FIFO1 output register	FIFO1 read
L	H	L	H	X	Active, Mail1 register	None
L	H	H	H	↑	Active, Mail1 register	Mail1 read (set $\overline{\text{MBF1}}$ HIGH)

Table 4. FIFO1 Flag Operation (CY Standard and FWFT modes)^[2]

Number of Words in FIFO Memory ^[5, 6, 7, 8]			Synchronized to $\overline{\text{CLKB}}$		Synchronized to $\overline{\text{CLKA}}$	
CY7C43642	CY7C43662	CY7C43682	$\overline{\text{EFB/ORB}}$	$\overline{\text{AEB}}$	$\overline{\text{AFA}}$	$\overline{\text{FFA/IRA}}$
0	0	0	L	L	H	H
1 TO X1	1 TO X1	1 TO X1	H	L	H	H
(X1+1) to [1024-(Y1+1)]	(X1+1) to [4096-(Y1+1)]	(X1+1) to [16384-(Y1+1)]	H	H	H	H
(1024-Y1) to 1023	(4096-Y1) to 4095	(16384-Y1) to 16383	H	H	L	H
1024	4096	16384	H	H	L	L

Table 5. FIFO2 Flag Operation (CY Standard and FWFT modes)^[2]

Number of Words in FIFO Memory ^[6, 7, 8, 9]			Synchronized to $\overline{\text{CLKA}}$		Synchronized to $\overline{\text{CLKB}}$	
CY7C43642	CY7C43662	CY7C43682	$\overline{\text{EFA/OR A}}$	$\overline{\text{AEA}}$	$\overline{\text{AFB}}$	$\overline{\text{FFB/IRB}}$
0	0	0	L	L	H	H
1 TO X2	1 TO X2	1 TO X2	H	L	H	H
(X2+1) to [1024-(Y2+1)]	(X2+1) to [4096-(Y2+1)]	(X2+1) to [16384-(Y2+1)]	H	H	H	H
(1024-Y2) to 1023	(4096-Y2) to 4095	(16384-Y2) to 16383	H	H	L	H
1024	4096	16384	H	H	L	L

Notes:

- X1 register holds the offset for $\overline{\text{AEB}}$; Y1 register holds the offset for $\overline{\text{AFA}}$.
- X2 register holds the offset for $\overline{\text{AEA}}$; Y2 register holds the offset for $\overline{\text{AFB}}$.
- X1 is the Almost Empty offset for FIFO1 used by $\overline{\text{AEB}}$. Y1 is the Almost Full offset for FIFO1 used by $\overline{\text{AFA}}$. Both X1 and Y1 are selected during a FIFO1 reset or port A programming.
- When a word loaded to an empty FIFO is shifted to the output register, its previous FIFO memory location is free.
- Data in the output register does not count as a "word in FIFO memory." Since in FWFT mode, the first word written to an empty FIFO goes unrequested to the output register (no read operation necessary), it is not included in the FIFO memory count.
- The ORA and IRB functions are active during FWFT mode; the EFA and FFB functions are active in CY Standard Mode.
- X2 is the Almost Empty offset for FIFO2 used by $\overline{\text{AEA}}$. Y2 is the Almost Full offset for FIFO2 used by $\overline{\text{AFB}}$. Both X2 and Y2 are selected during a FIFO2 reset or port A programming.



Maximum Ratings^[10,11]

(Above which the useful life may be impaired. For user guidelines, not tested.)

- Storage Temperature -65°C to +150°C
- Ambient Temperature with Power Applied..... -55°C to +125°C
- Supply Voltage to Ground Potential -0.5V to +7.0V
- DC Voltage Applied to Outputs in High-Z State^[12] -0.5V to V_{CC}+0.5V
- DC Input Voltage^[12] -0.5V to V_{CC}+0.5V
- Output Current into Outputs (LOW) 20 mA

- Static Discharge Voltage..... > 2001V (per MIL-STD-883, Method 3015)
- Latch-up Current..... > 200mA

Operating Range

Range	Ambient Temperature	V _{CC} ^[13]
Commercial	0°C to +70°C	5.0V ± 0.5V
Industrial	-40°C to +85°C	5.0V ± 0.5V

Electrical Characteristics Over the Operating Range

Parameter	Description	Test Conditions	CY7C43642/62/82		Unit
			Min.	Max.	
V _{OH}	Output HIGH Voltage	V _{CC} = 4.5V, I _{OH} = -4.0 mA	2.4		V
V _{OL}	Output LOW Voltage	V _{CC} = 4.5V, I _{OL} = 8.0 mA		0.5	V
V _{IH}	Input HIGH Voltage		2.0	V _{CC}	V
V _{IL}	Input LOW Voltage		-0.5	0.8	V
I _{IX}	Input Leakage Current	V _{CC} = Max.	-10	+10	µA
I _{OZL} I _{OZH}	Output OFF, High-Z Current	$\overline{OE} \geq V_{IH}$, V _{SS} < V _O < V _{CC}	-10	+10	µA
I _{CC1} ^[14]	Active Power Supply Current		Com'l	100	mA
			Ind	100	mA
I _{SB} ^[15]	Average Standby Current		Com'l	10	mA
			Ind	10	mA

Capacitance^[16]

Parameter	Description	Test Conditions	Max.	Unit
C _{IN}	Input Capacitance	T _A = 25°C, f = 1 MHz, V _{CC} = 3.3V	4	pF
C _{OUT}	Output Capacitance		8	pF

Notes:

10. Stresses beyond those listed under "Absolute Maximum Ratings" may cause permanent damage to the device. These are stress ratings only and functional operation of the device at these or any other conditions beyond those indicated under "recommended operating conditions" is not implied. Exposure to absolute-maximum-rated conditions for extended periods may affect device reliability.
11. The Voltage on any input or I/O pin cannot exceed the power pin during power-up.
12. The input and output voltage ratings may be exceeded provided the input and output current ratings are observed.
13. Operating V_{CC} Range for -7 speed is 5.0V ± 0.25V.
14. Input signals switch from 0V to 3V with a rise/fall time of less than 3 ns, clocks and clock enables switch at 20 MHz, while data inputs switch at 10 MHz. Outputs are unloaded.
15. All inputs = V_{CC} - 0.2V, except RCLK and WCLK (which are at frequency = 0 MHz). All outputs are unloaded.
16. Tested initially and after any design or process changes that may affect these parameters.

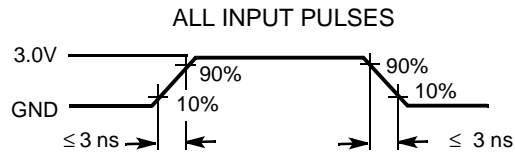
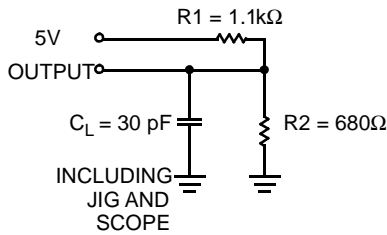
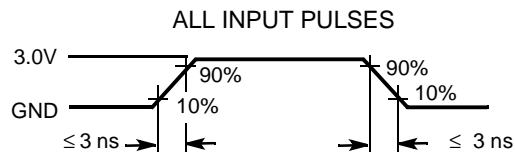
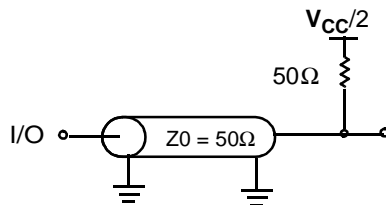
AC Test Loads and Waveforms (-10 and -15)

AC Test Loads and Waveforms (-7)

Switching Characteristics Over the Operating Range

Parameter	Description	CY7C43642/62/82 -7		CY7C43642/62/82 -10		CY7C43642/62/82 -15		Unit
		Min.	Max.	Min.	Max.	Min.	Max.	
f_s	Clock Frequency, CLKA or CLKB		133		100		67	MHz
t_{CLK}	Clock Cycle Time, CLKA or CLKB	7.5		10		15		ns
t_{CLKH}	Pulse Duration, CLKA or CLKB HIGH	3.5		4		6		ns
t_{CLKL}	Pulse Duration, CLKA or CLKB LOW	3.5		4		6		ns
t_{DS}	Set-up Time, A_{0-35} before CLKA \uparrow and B_{0-35} before CLKB \uparrow	3		4		5		ns
t_{ENS}	Set-up Time, CSA, W/RA, ENA, and MBA before CLKA \uparrow ; CSB, W/RB, ENB, and MBB before CLKB \uparrow	3		4		5		ns
t_{RSTS}	Set-up Time, RST1, RST2, RT1 or RT2 LOW before CLKA \uparrow or CLKB \uparrow ^[17]	2.5		4		5		ns
t_{FSS}	Set-up Time, FS0 and FS1 before RST1 and RST2 HIGH	6		7		7.5		ns
t_{SDS}	Set-up Time, FS0 before CLKA \uparrow	3		4		5		ns
t_{SENS}	Set-up Time, FS1 before CLKA \uparrow	3		4		5		ns
t_{FWS}	Set-up Time, FWFT before CLKA \uparrow	0		0		0		ns
t_{DH}	Hold Time, A_{0-35} after CLKA \uparrow and B_{0-35} after CLKB \uparrow	0		0		0		ns
t_{ENH}	Hold Time, CSA, W/RA, ENA, and MBA after CLKA \uparrow ; CSB, W/RB, ENB, and MBB after CLKB \uparrow	0		0		0		ns
t_{RSTH}	Hold Time, RST1, RST2, RT1 or RT2 LOW after CLKA \uparrow or CLKB \uparrow ^[17]	1		2		4		ns
t_{FSH}	Hold Time, FS0 and FS1 after RST1 and RST2 HIGH	1		1		2		ns
t_{SDH}	Hold Time, FS0 after CLKA \uparrow	0		0		0		ns
t_{SENH}	Hold Time, FS1 after CLKA \uparrow	0		0		0		ns

Note:

17. Skew time is not a timing constraint for proper device operation and is only included to illustrate the timing relationship between the CLKA cycle and the CLKB cycle.



Switching Characteristics Over the Operating Range (continued)

Parameter	Description	CY7C43642/62/82 -7		CY7C43642/62/82 -10		CY7C43642/62/82 -15		Unit
		Min.	Max.	Min.	Max.	Min.	Max.	
t _{SPH}	Hold Time, FS1 HIGH after RST1 and RST2 HIGH	0		1		2		ns
t _{SKEW1} ^[17]	Skew Time between CLKA↑ and CLKB↑ for EFA/ORA, EFB/ORB, FFA/IRA, and FFB/IRB	5		5		7.5		ns
t _{SKEW2} ^[17]	Skew Time between CLKA↑ and CLKB↑ for AEA, AEB, AFA, AFB	7		8		12		ns
t _A	Access Time, CLKA↑ to A ₀₋₃₅ and CLKB↑ to B ₀₋₃₅	1	6	1	8	3	10	ns
t _{WFF}	Propagation Delay Time, CLKA↑ to FFA/IRA and CLKB↑ to FFB/IRB	1	6	1	8	2	8	ns
t _{REF}	Propagation Delay Time, CLKA↑ to EFA/ORA and CLKB↑ to EFB/ORB	1	6	1	8	1	8	ns
t _{PAE}	Propagation Delay Time, CLKA↑ to AEA and CLKB↑ to AEB	1	6	1	8	1	8	ns
t _{PAF}	Propagation Delay Time, CLKA↑ to AFA and CLKB↑ to AFB	1	6	1	8	1	8	ns
t _{PMF}	Propagation Delay Time, CLKA↑ to MBF1 LOW or MBF2 HIGH and CLKB↑ to MBF2 LOW or MBF1 HIGH	0	6	0	8	0	12	ns
t _{PMR}	Propagation Delay Time, CLKA↑ to B ₀₋₃₅ ^[18] and CLKB↑ to A ₀₋₃₅ ^[19]	1	7	2	11	3	12	ns
t _{MDV}	Propagation Delay Time, MBA to A ₀₋₃₅ valid and MBB to B ₀₋₃₅ valid ^[20]	1	6	2	9	3	11	ns
t _{RSF}	Propagation Delay Time, RST1 LOW to AEB LOW, AFA HIGH, FFA/IRA Low, EFB/ORB LOW, and MBF1 HIGH and RST2 LOW to AEA LOW, AFB HIGH, FFB/IRB Low, EFA/ORA LOW, and MBF2 HIGH	1	6	1	10	1	15	ns
t _{EN}	Enable Time, CSA or W/RA LOW to A ₀₋₃₅ Active and CSB LOW and W/RB HIGH to B ₀₋₃₅ Active	1	6	2	8	2	10	ns
t _{DIS}	Disable Time, CSA or W/RA HIGH to A ₀₋₃₅ at High Impedance and CSB HIGH or W/RB LOW to B ₀₋₃₅ at High Impedance	1	5	1	6	1	8	ns
t _{RTR}	Retransmit Recovery Time	90		90		90		ns

Notes:

18. Writing data to the Mail1 register when the B₀₋₃₅ outputs are active and MBB is HIGH.
19. Writing data to the Mail2 register when the A₀₋₃₅ outputs are active and MBA is HIGH.
20. Requirement to count the clock edge as one of at least four needed to reset a FIFO.

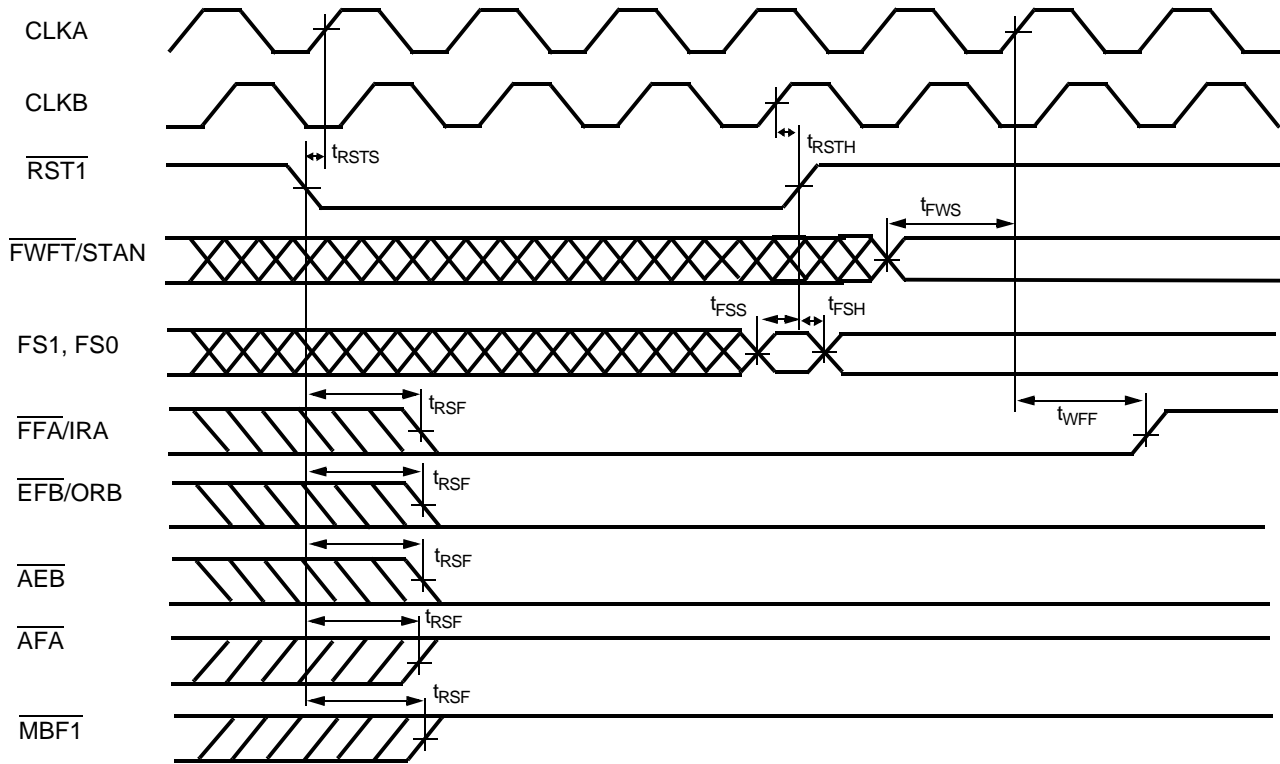
Switching Waveforms
FIFO1 Reset Loading X1 and Y1 with a Preset Value of Eight [21]

Note:

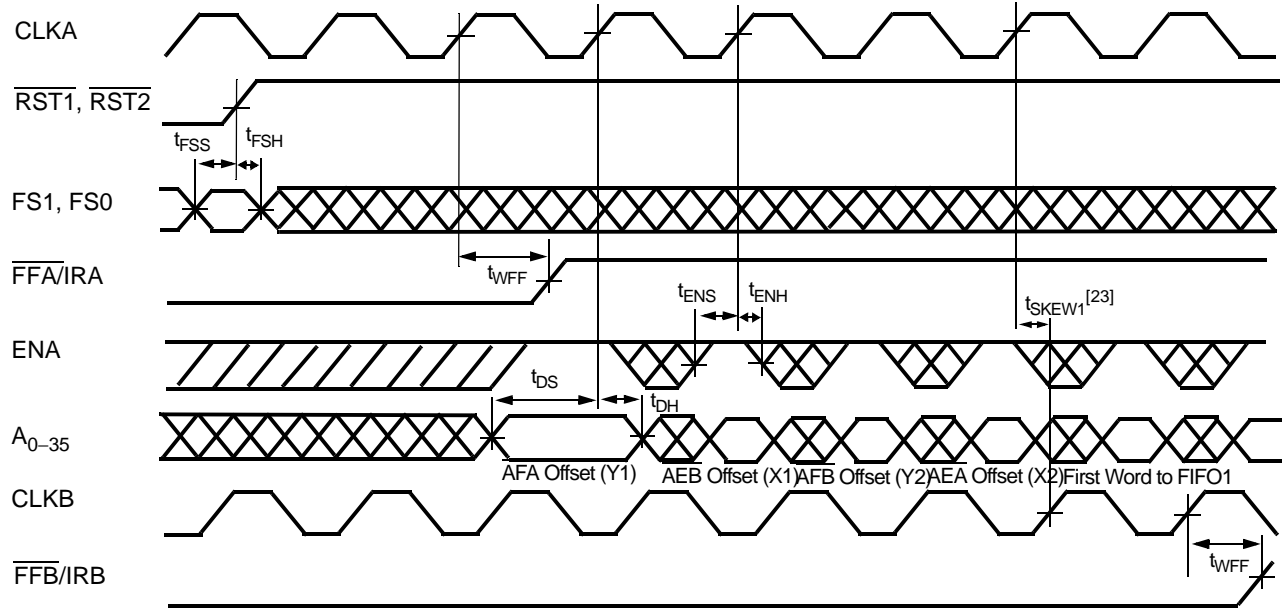
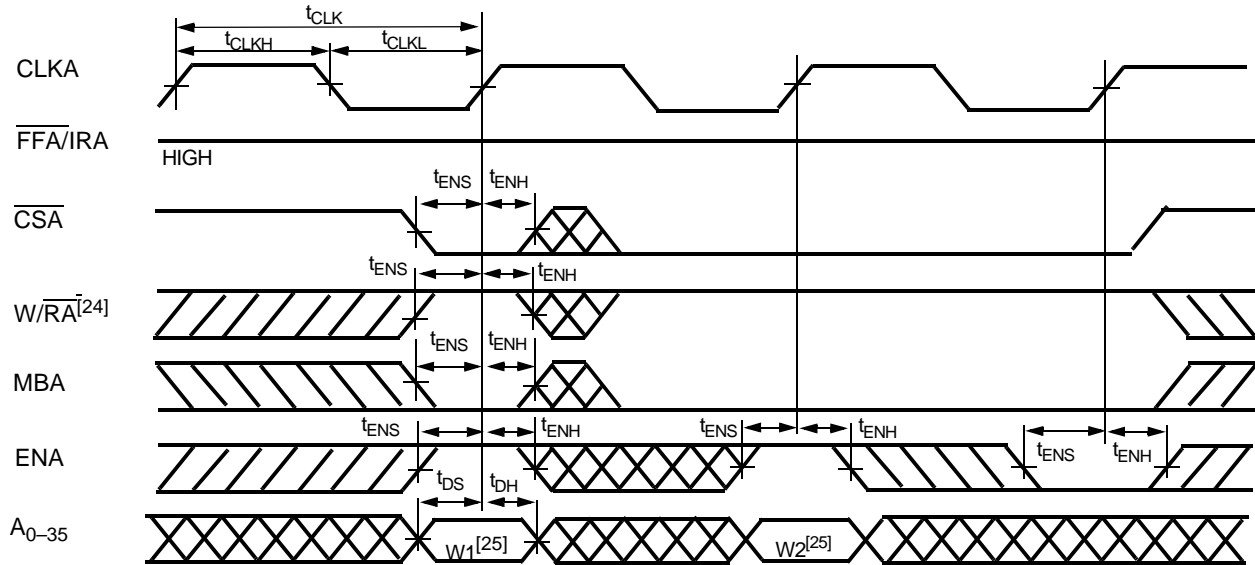
21. Reset is performed in the same manner for FIFO2 to load X2 and Y2 with a preset value.

Switching Waveforms (continued)
Programming of the Almost-Full Flag and Almost-Empty Flag Offset Values after Reset (CY Standard and FWFT Modes) [22]

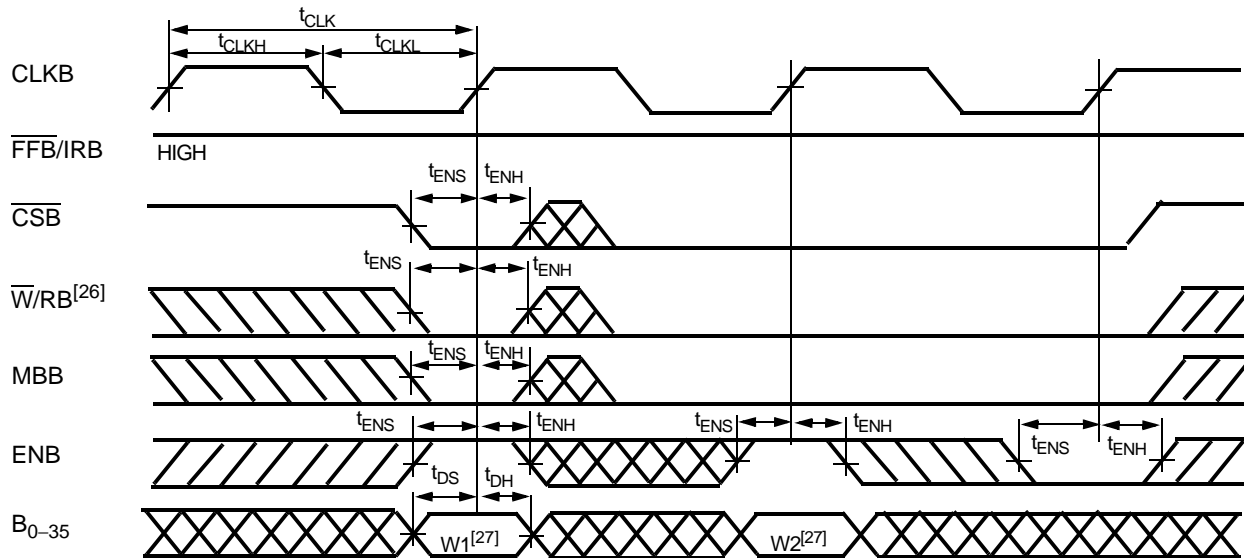
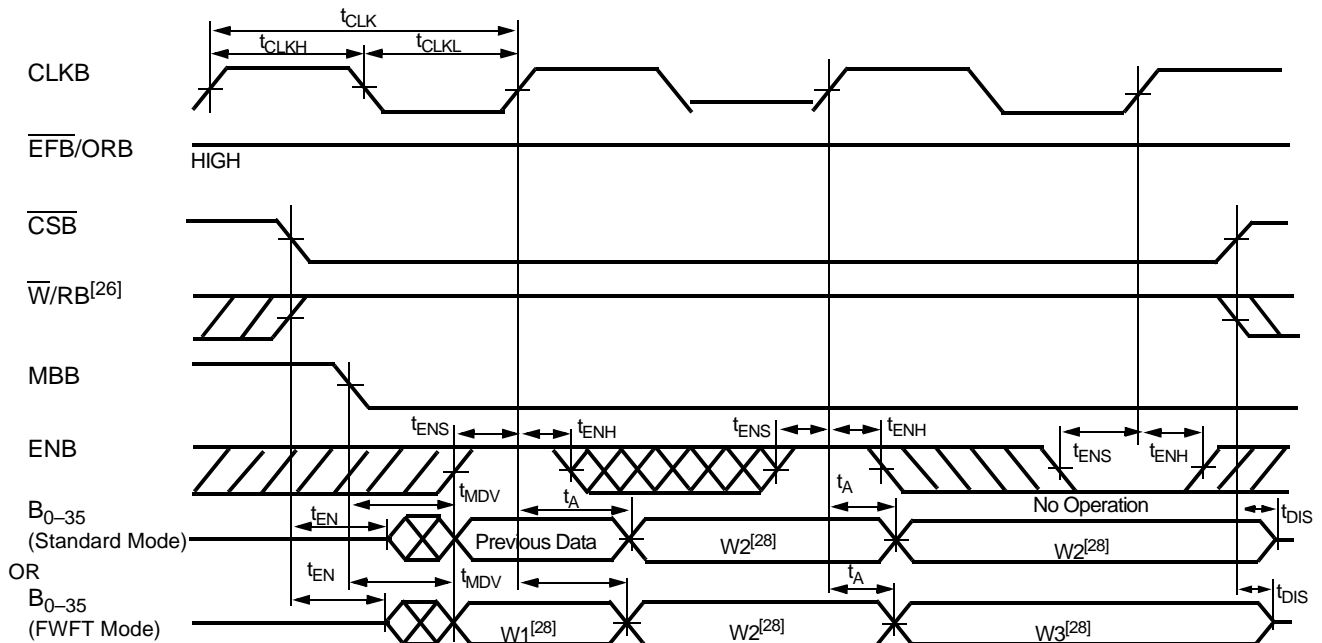
Port A Write Cycle Timing for FIFO1 (CY Standard and FWFT Modes)

Notes:

22. $\overline{CSA} = \text{LOW}$, $W/\overline{RA} = \text{HIGH}$, $MBA = \text{LOW}$. It is not necessary to program offset register on consecutive clock cycles.
23. t_{SKEW1} is the minimum time between the rising CLKA edge and a rising CLKB for FFB/IRB to transition HIGH in the next cycle. If the time between the rising edge of CLKA and rising edge of CLKB is less than t_{SKEW1} , then FFB/IRB may transition HIGH one cycle later than shown.
24. If W/\overline{RA} switches from read to write before the assertion of \overline{CSA} , $t_{\text{ENS}} = t_{\text{DIS}} + t_{\text{ENS}}$.
25. Written to FIFO1.

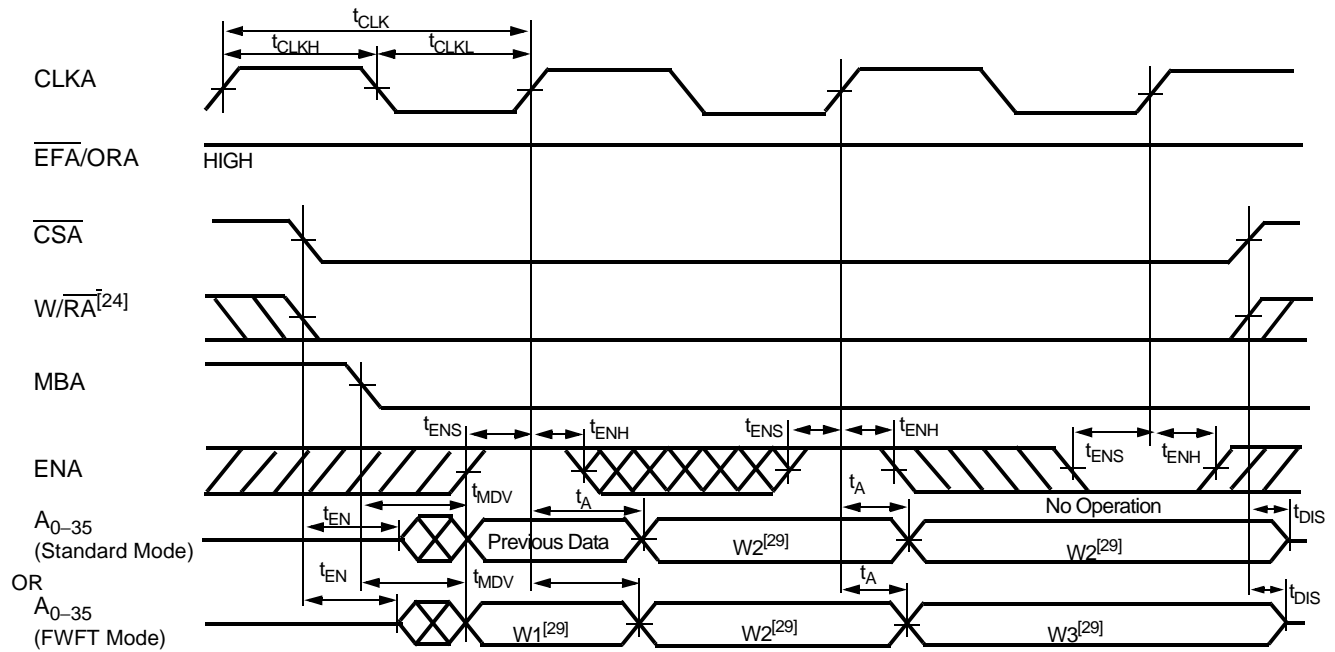
Switching Waveforms (continued)
Port B Write Cycle Timing for FIFO2 (CY Standard and FWFT Modes)

Port B Read Cycle Timing for FIFO1 (CY Standard and FWFT Modes)^[1]

Notes:

26. If W/RB switches from read to write before the assertion of CSB, $t_{ENS} = t_{DIS} + t_{ENS}$.
27. Written to FIFO2.
28. Read from FIFO1.

Switching Waveforms (continued)
Port A Read Cycle Timing for FIFO2 (CY Standard and FWFT Modes)^[1]

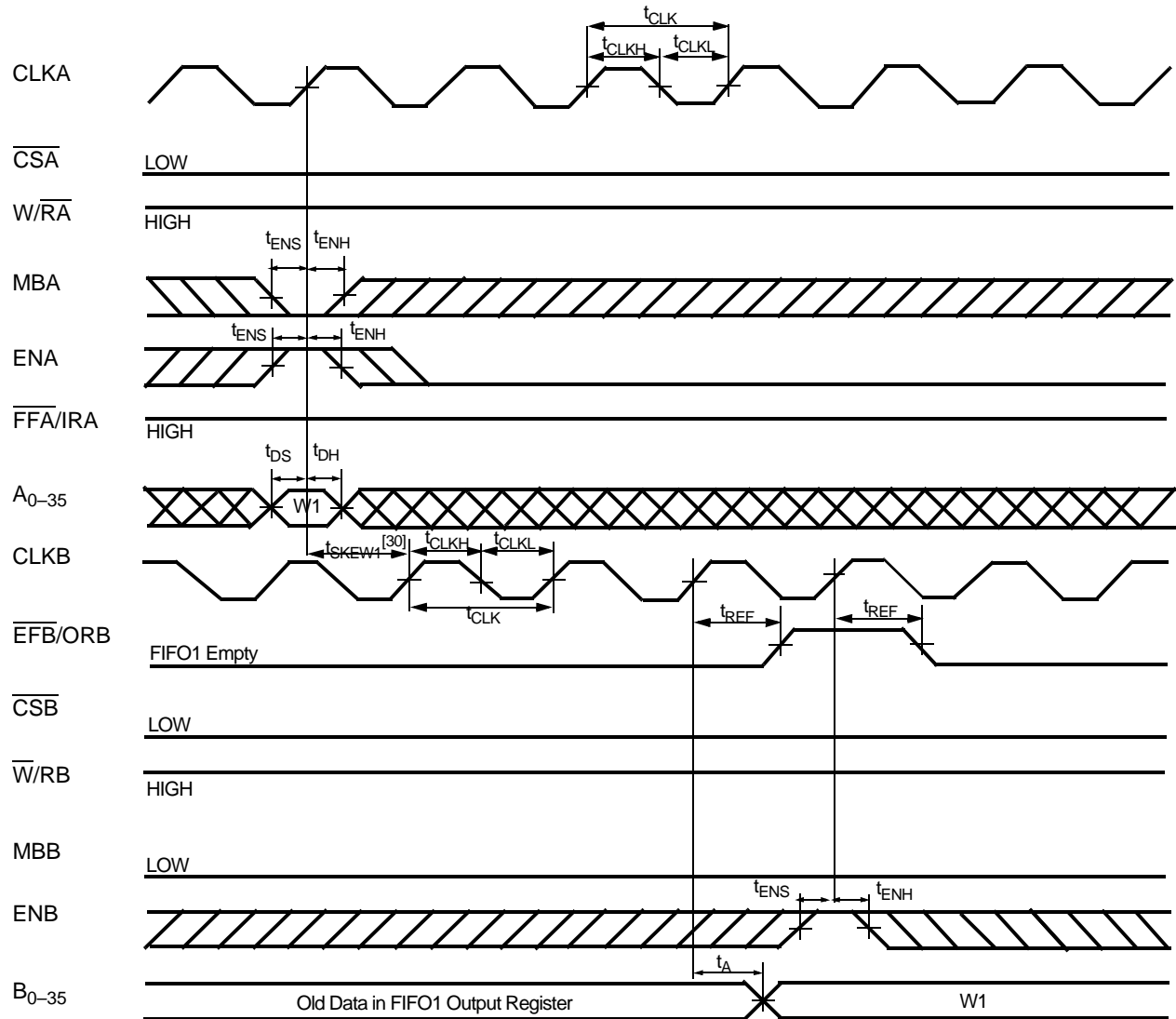
Note:
 29. Read From FIFO2.

Switching Waveforms (continued)

ORB Flag Timing and First Data Word Fall Through when FIFO1 is Empty (FWFT Mode)^[1]

Note:

30. t_{SKEW1} is the minimum time between a rising CLKA edge and a rising CLKB edge for ORB to transition HIGH and to clock the next word to the FIFO1 output register in three CLKB cycles. If the time between the rising CLKA edge and rising CLKB edge is less than t_{SKEW1} , then the transition of ORB HIGH and load of the first word to the output register may occur one CLKB cycle later than shown.

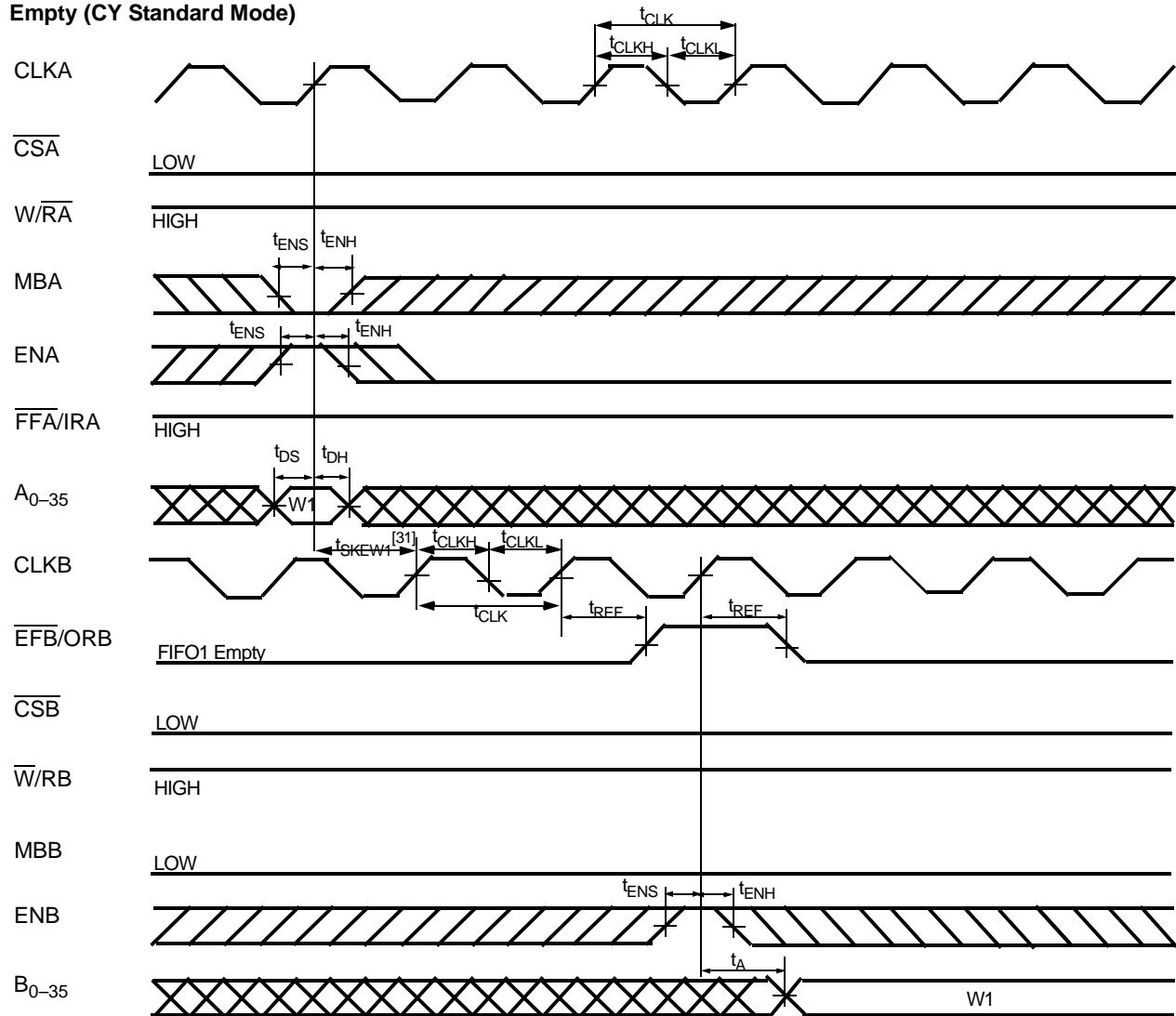
Switching Waveforms (continued)

 $\overline{\text{EFB}}$ Flag Timing and First Data Read Fall Through when FIFO1 is Empty (CY Standard Mode)

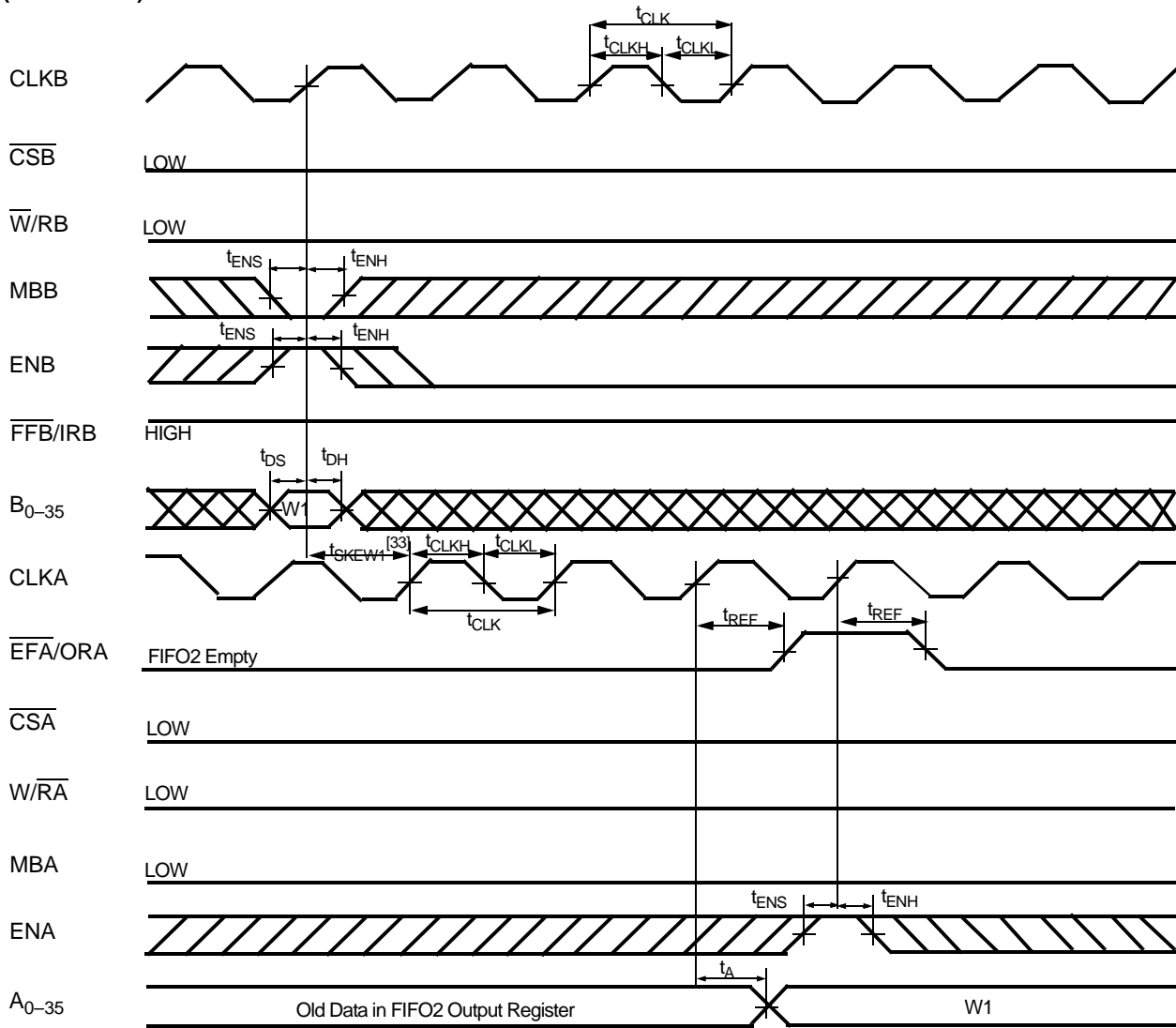
Note:

31. t_{SKEW1} is the minimum time between a rising CLKA edge and a rising CLKB edge for $\overline{\text{EFB}}$ to transition HIGH in the next CLKB cycle. If the time between the rising CLKA edge and rising CLKB edge is less than t_{SKEW1} , then the transition of $\overline{\text{EFB}}$ HIGH may occur one CLKB cycle later than shown.

Switching Waveforms (continued)
**ORA Flag Timing and First Data Word Fall Through when FIFO2 is Empty^[1]
(FWFT Mode)^[32]**

Notes:

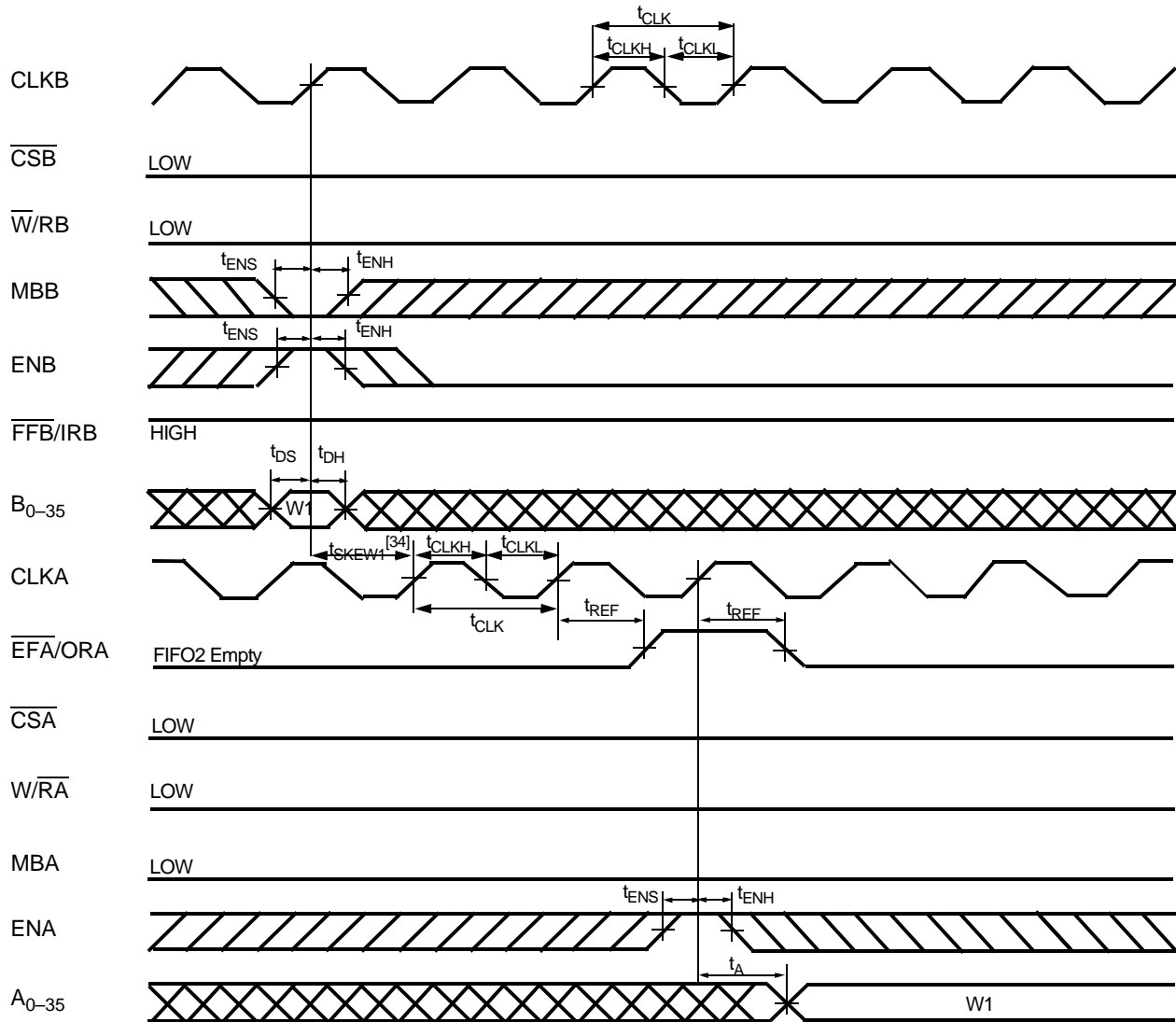
32. t_{SKEW1} is referenced to the rising CLKB edge that writes the last word or byte of the long word, respectively.
33. t_{SKEW1} is the minimum time between a rising CLKB edge and a rising CLKA edge for ORA to transition HIGH and to clock the next word to the FIFO2 output register in three CLKA cycles. If the time between the rising CLKB edge and rising CLKA edge is less than t_{SKEW1}, then the transition of ORA HIGH and load of the first word to the output register may occur one CLKA cycle later than shown.

Switching Waveforms (continued)

EFA Flag Timing and First Data Read when FIFO2 is Empty (CY Standard Mode)

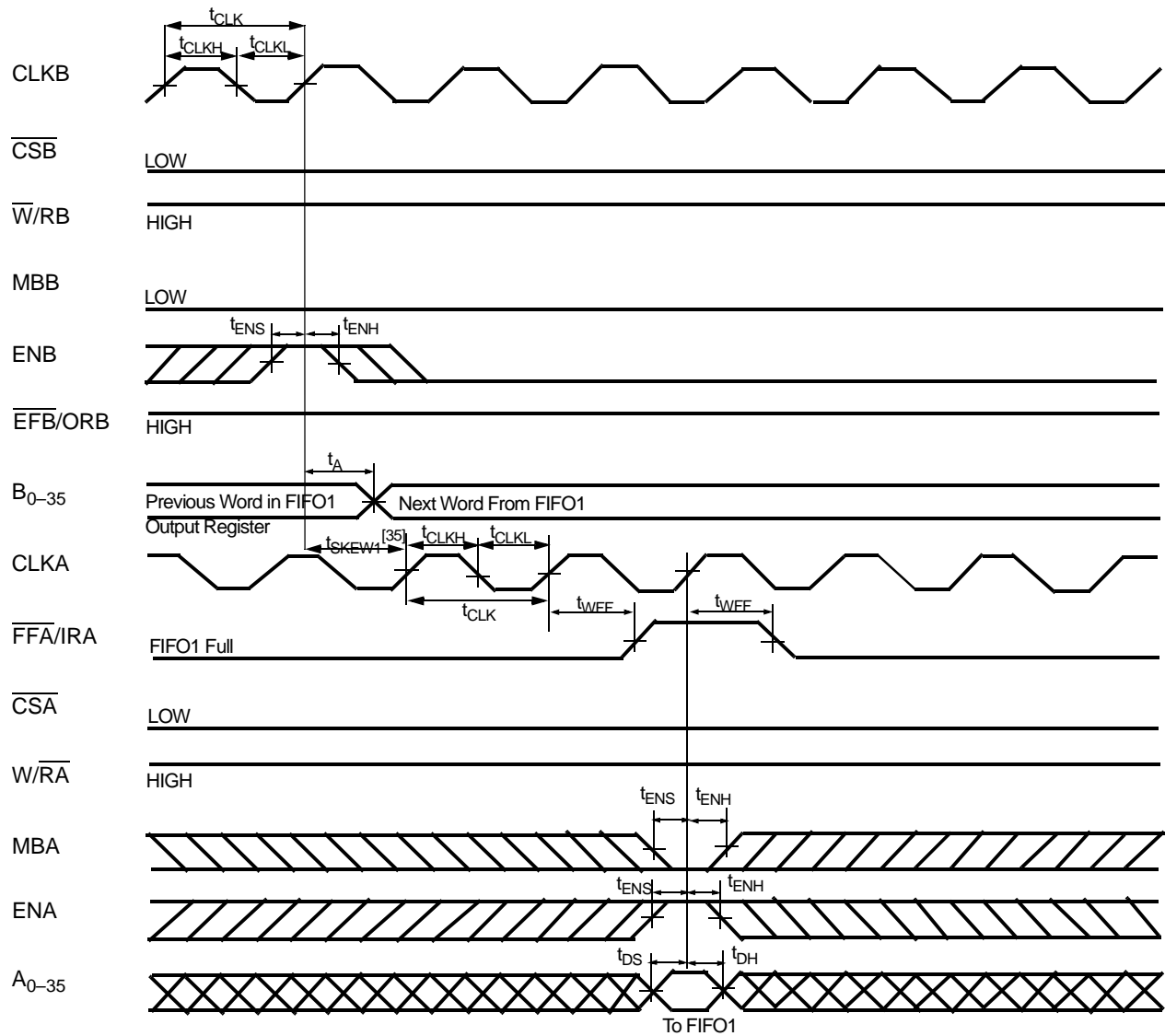
Note:

34. t_{SKEW1} is the minimum time between a rising CLKB edge and a rising CLKA edge for EFA to transition HIGH in the next CLKA cycle. If the time between the rising CLKB edge and rising CLKA edge is less than t_{SKEW1} , then the transition of EFA HIGH may occur one CLKA cycle later than shown.

Switching Waveforms (continued)
IRA Flag Timing and First Available Write when FIFO1 is Full (FWFT Mode)

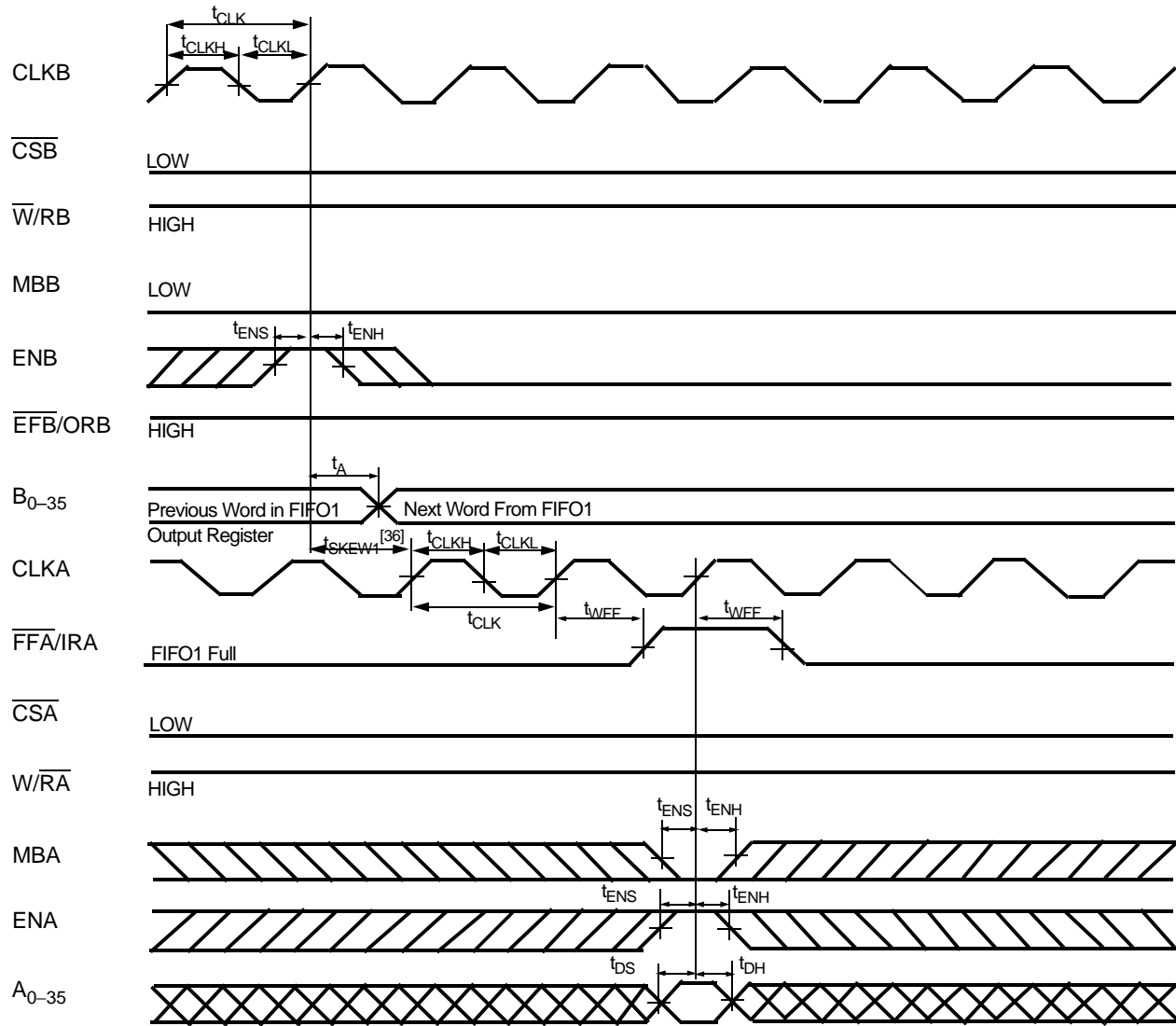
Note:

35. t_{SKEW1} is the minimum time between a rising CLKB edge and a rising CLKA edge for IRA to transition HIGH in the next CLKA cycle. If the time between the rising CLKB edge and rising CLKA edge is less than t_{SKEW1} , then IRA may transition HIGH one CLKA cycle later than shown.

Switching Waveforms (continued)
FFA Flag Timing and First Available Write when FIFO1 is Full (CY Standard Mode)

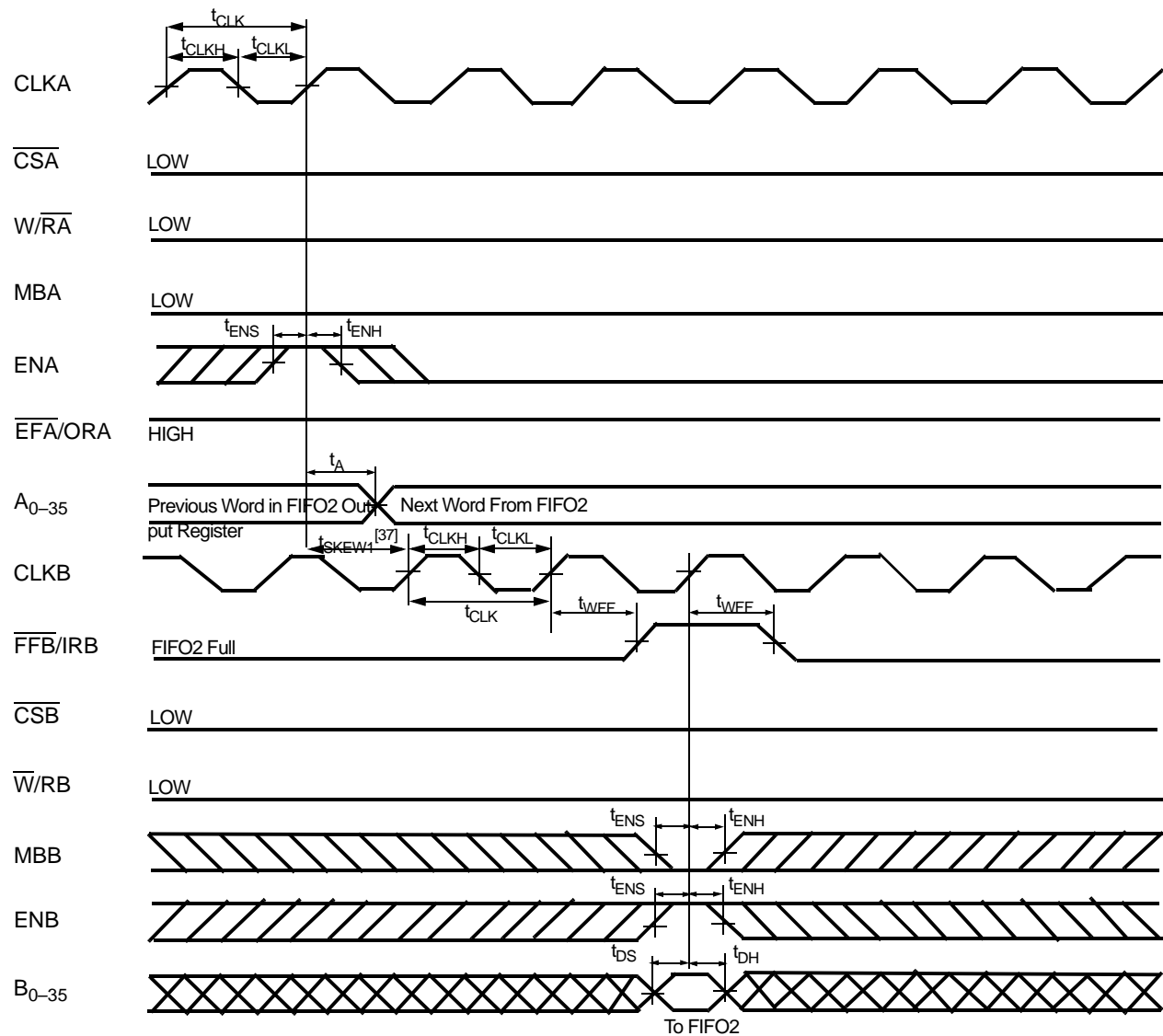
Note:

36. t_{SKEW1} is the minimum time between a rising CLKB edge and a rising CLKA edge for \overline{FFA} to transition HIGH in the next CLKA cycle. If the time between the rising CLKB edge and rising CLKA edge is less than t_{SKEW1} , then the transition of \overline{FFA} HIGH may occur one CLKA cycle later than shown.

Switching Waveforms (continued)
IRB Flag Timing and First Available Write when FIFO2 is Full (FWFT Mode)

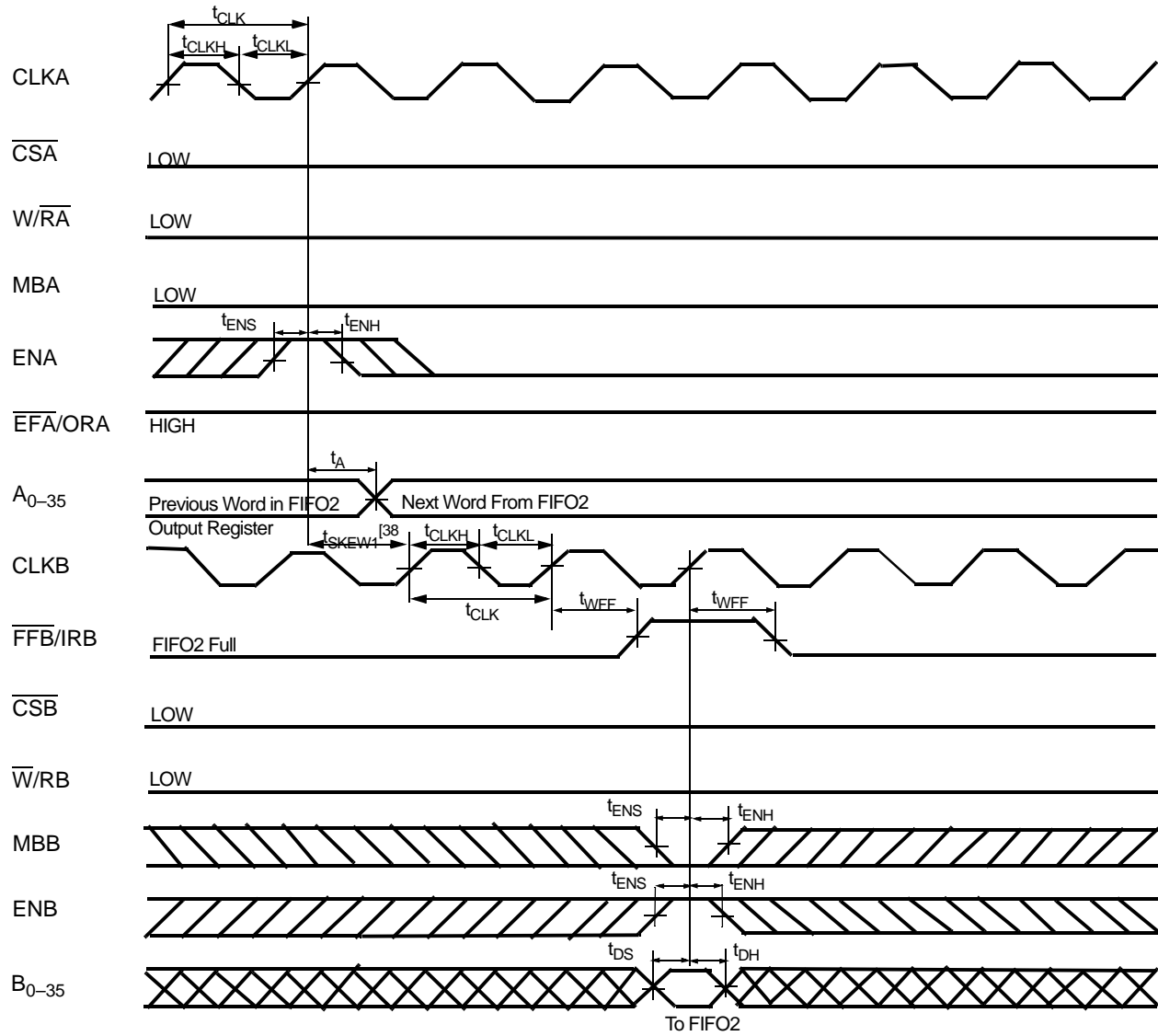
Note:

37. t_{SKEW1} is the minimum time between a rising CLKA edge and a rising CLKB edge for IRB to transition HIGH in the next CLKB cycle. If the time between the rising CLKA edge and rising CLKB edge is less than t_{SKEW1} , then the transition of IRB HIGH may occur one CLKB cycle later than shown.

Switching Waveforms (continued)
FFB Flag Timing and First Available Write when FIFO2 is Full (CY Standard Mode)

Note:

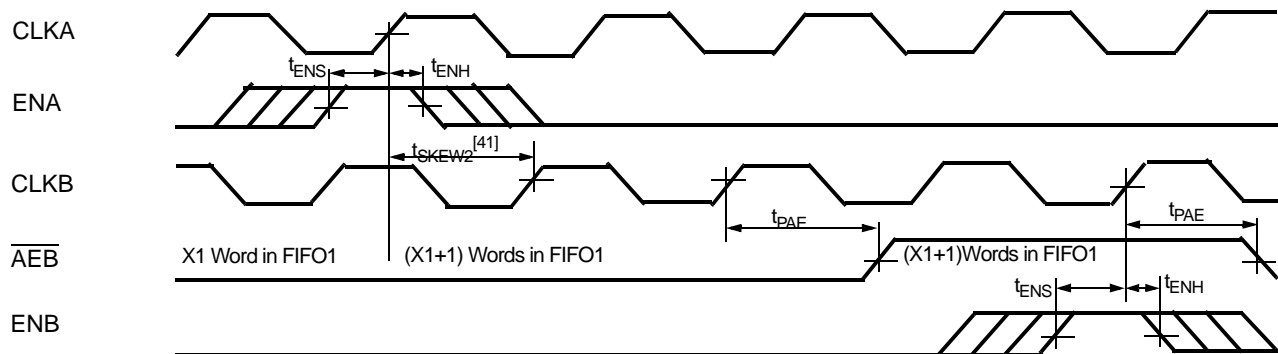
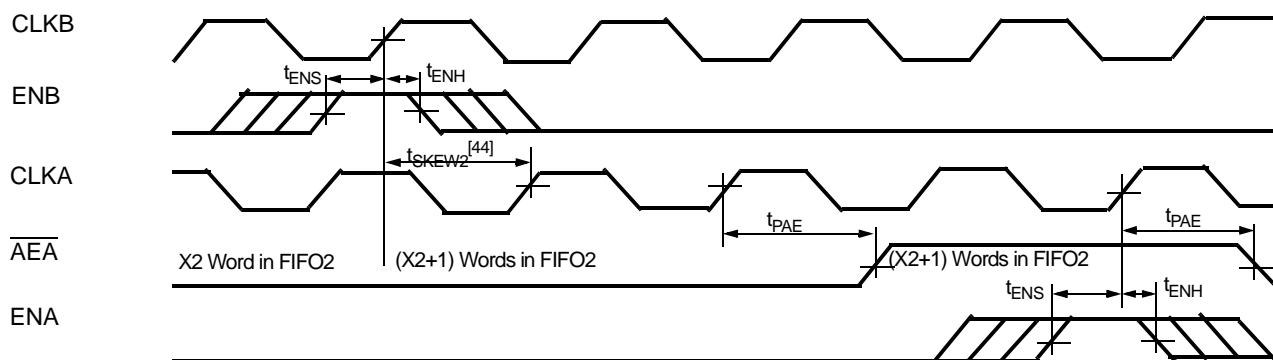
38. t_{SKEW1} is the minimum time between a rising CLKA edge and a rising CLKB edge for \overline{FFB} to transition HIGH in the next CLKB cycle. If the time between the rising CLKA edge and rising CLKB edge is less than t_{SKEW1} , then the transition of FFB HIGH may occur one CLKB cycle later than shown.

Switching Waveforms (continued)

Timing for $\overline{\text{AEB}}$ when FIFO1 is Almost Empty (CY Standard and FWFT Modes) ^[39, 40,2]

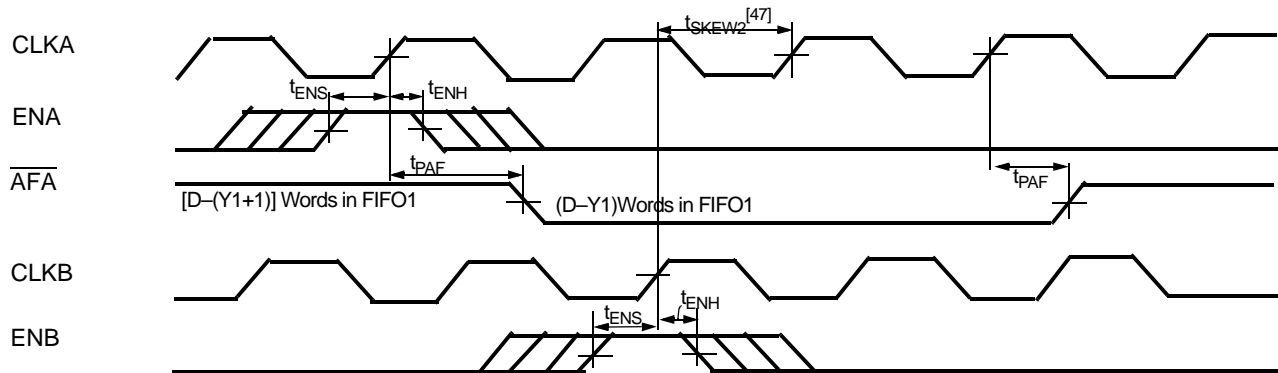
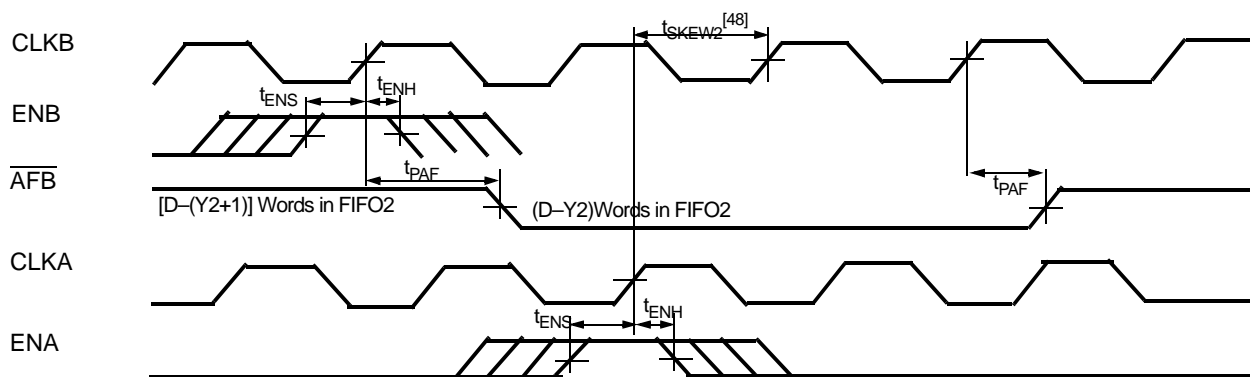
Timing for $\overline{\text{AEA}}$ when FIFO2 is Almost Empty (CY Standard and FWFT Modes) ^[42, 43,2]

Notes:

39. FIFO1 Write ($\overline{\text{CSA}} = \text{LOW}$, $\text{W}/\overline{\text{RA}} = \text{LOW}$, $\text{MBA} = \text{LOW}$), FIFO1 Read ($\overline{\text{CSB}} = \text{LOW}$, $\overline{\text{W}}/\text{RB} = \text{HIGH}$, $\text{MBB} = \text{LOW}$). Data in the FIFO1 output register has been read from the FIFO.
40. If Port B size is word or byte, $\overline{\text{AEB}}$ is set LOW by the last word or byte read from FIFO1, respectively.
41. t_{SKEW2} is the minimum time between a rising CLKA edge and a rising CLKB edge for AEB to transition HIGH in the next CLKB cycle. If the time between the rising CLKA edge and rising CLKB edge is less than t_{SKEW2} , then AEB may transition HIGH one CLKB cycle later than shown.
42. FIFO2 Write ($\text{CSB} = \text{LOW}$, $\text{W}/\text{RB} = \text{LOW}$, $\text{MBB} = \text{LOW}$), FIFO2 Read ($\text{CSA} = \text{LOW}$, $\text{W}/\text{RA} = \text{LOW}$, $\text{MBA} = \text{LOW}$). Data in the FIFO2 output register has been read from the FIFO.
43. If Port B size is word or byte, t_{SKEW2} is referenced to the rising CLKB edge that writes the last word or byte of the long word, respectively.
44. t_{SKEW2} is the minimum time between a rising CLKB edge and a rising CLKA edge for AEA to transition HIGH in the next CLKA cycle. If the time between the rising CLKB edge and rising CLKA edge is less than t_{SKEW2} , then AEA may transition HIGH one CLKA cycle later than shown.

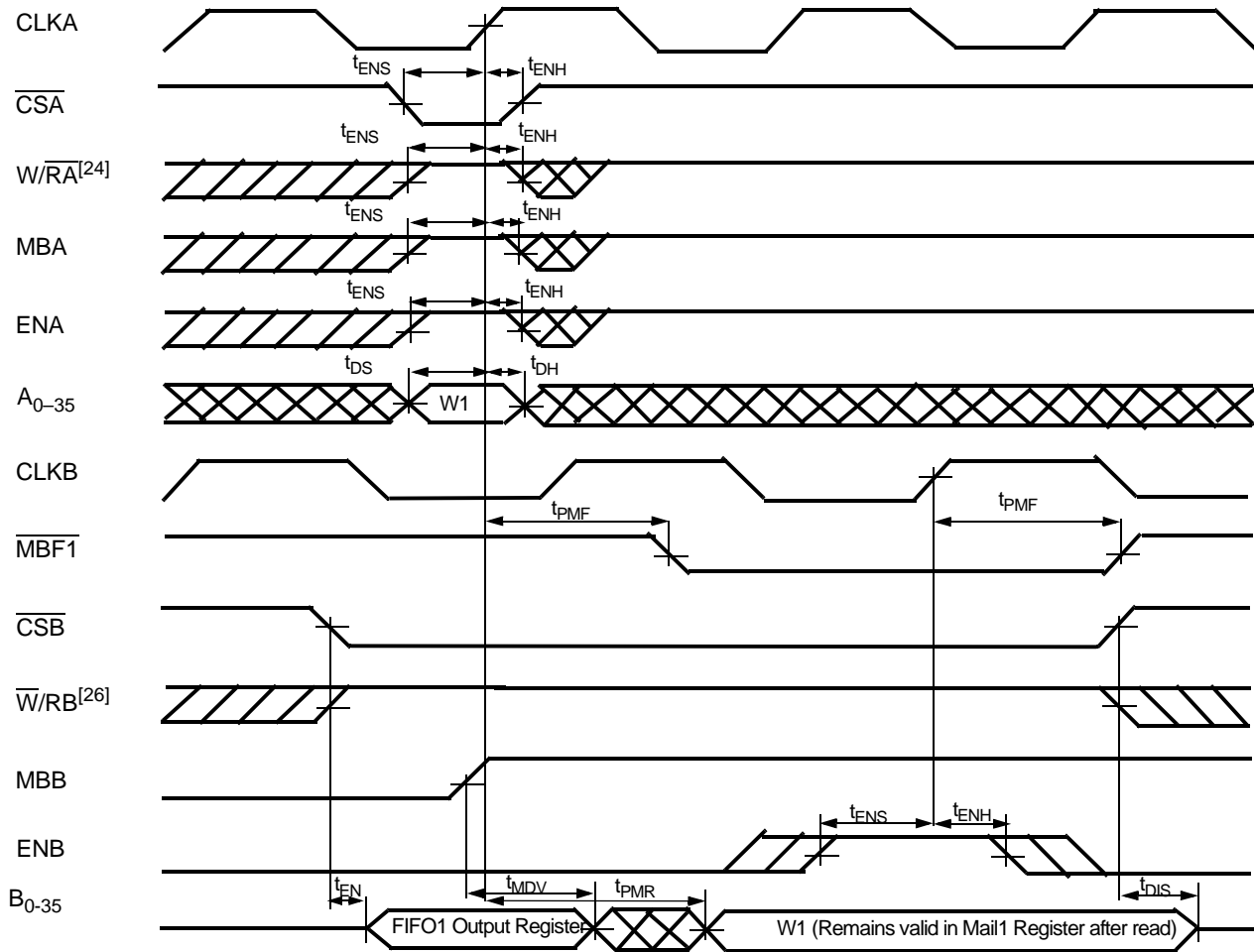
Switching Waveforms (continued)
Timing for $\overline{\text{AFA}}$ when FIFO1 is Almost Full (CY Standard and FWFT Modes)^[43,2,45, 46]

Timing for $\overline{\text{AFB}}$ when FIFO2 is Almost Full (CY Standard and FWFT Modes)^[42,2, 46]

Notes:

45. FIFO1 Write ($\overline{\text{CSA}} = \text{LOW}$, $\text{W}/\overline{\text{RA}} = \text{HIGH}$, $\text{MBA} = \text{LOW}$), FIFO1 Read ($\overline{\text{CSB}} = \text{LOW}$, $\overline{\text{W}}/\overline{\text{RB}} = \text{HIGH}$, $\text{MBB} = \text{LOW}$). Data in the FIFO1 output register has been read from the FIFO.
46. D = Maximum FIFO Depth 1K for the CY7C43642, 4K for the CY7C43662, and 16K for the CY7C43682.
47. t_{SKEW2} is the minimum time between a rising CLKA edge and a rising CLKB edge for AFA to transition HIGH in the next CLKA cycle. If the time between the rising CLKA edge and rising CLKB edge is less than t_{SKEW2} , then AFA may transition HIGH one CLKB cycle later than shown.
48. t_{SKEW2} is the minimum time between a rising CLKB edge and a rising CLKA edge for AFB to transition HIGH in the next CLKB cycle. If the time between the rising CLKB edge and rising CLKA edge is less than t_{SKEW2} , then AFB may transition HIGH one CLKA cycle later than shown.

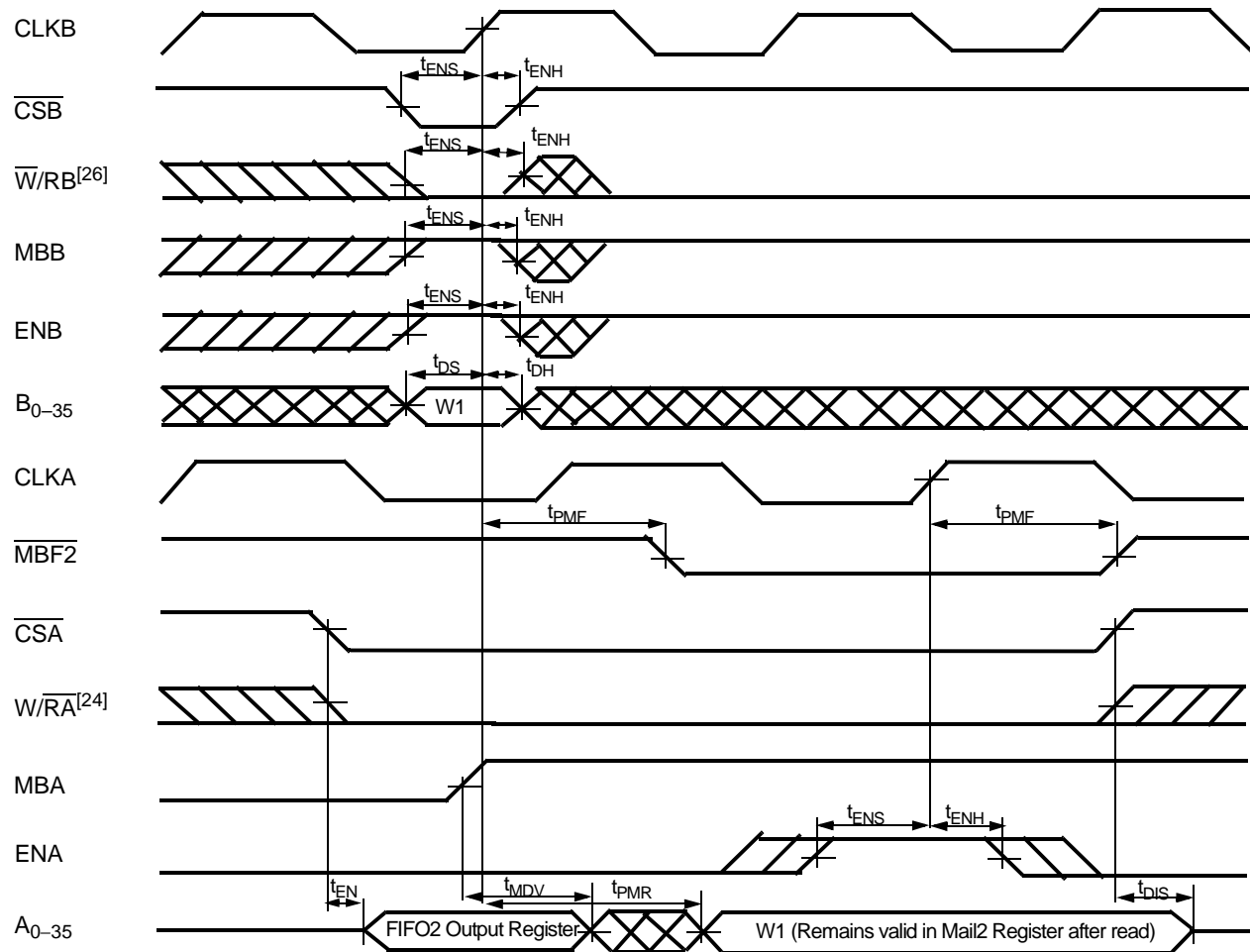
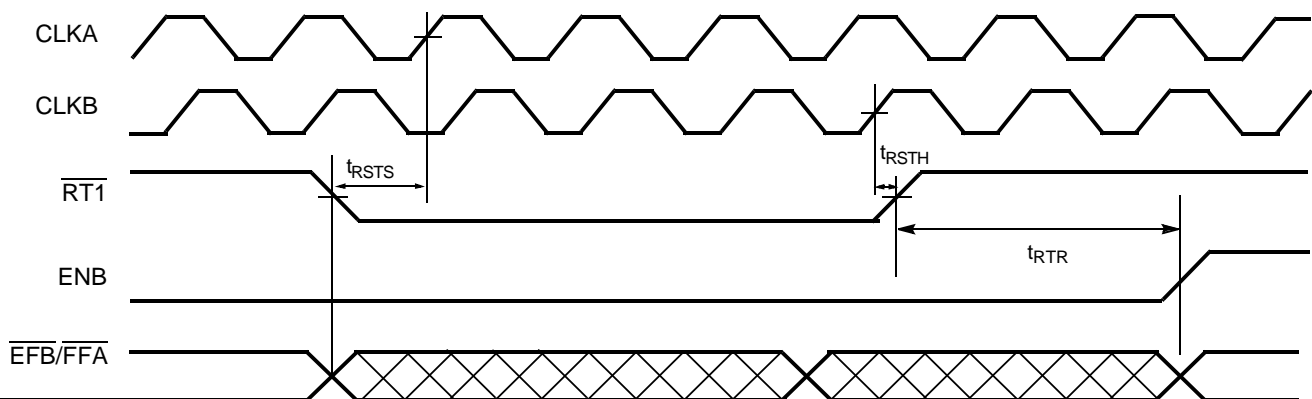
Switching Waveforms (continued)
Timing for Mail1 Register and $\overline{\text{MBF1}}$ Flag (CY Standard and FWFT Modes) ^[49]

49. Simultaneous writing to and reading from mailbox register is not allowed.

Switching Waveforms (continued)
Timing for Mail2 Register and $\overline{\text{MBF2}}$ Flag (CY Standard and FWFT Modes) ^[49]

FIFO1 Retransmit Timing ^[50,51,52,53,54]

Notes:

50. Retransmit is performed in the same manner for FIFO2.
51. Clocks are free-running in this case. CY standard mode only. Write operation should be prohibited one write clock cycle before the falling edge of $\overline{\text{RT1}}$, and during the retransmit operation, i.e. when RT1 is LOW and t_{RTR} after the RT1 rising edge.
52. The Empty and Full flags may change state during Retransmit as a result of the offset of the read and write pointers, but flags will be valid at t_{RTR} .
53. For the AEA, AEB, AFA, and AFB flags, two clock cycle are necessary after t_{RTR} to update these flags.
54. The number of 36-/18-/9-bit words written into the FIFO should be less than full depth minus 2/4/8 words between the reset of the FIFO (master or partial) and the Retransmit setup.

Ordering Information

1K x36 x2 Bidirectional Synchronous FIFO

Speed (ns)	Ordering Code	Package Name	Package Type	Operating Range
7	CY7C43642-7AC	A120	120-lead Thin Quad Flat Package	Commercial
10	CY7C43642-10AC	A120	120-lead Thin Quad Flat Package	Commercial
15	CY7C43642-15AC	A120	120-lead Thin Quad Flat Package	Commercial

4K x36 x2 Bidirectional Synchronous FIFO

Speed (ns)	Ordering Code	Package Name	Package Type	Operating Range
7	CY7C43662-7AC	A120	120-lead Thin Quad Flat Package	Commercial
10	CY7C43662-10AC	A120	120-lead Thin Quad Flat Package	Commercial
15	CY7C43662-15AC	A120	120-lead Thin Quad Flat Package	Commercial

Speed (ns)	Ordering Code	Package Name	Package Type	Operating Range
7	CY7C43682-7AC	A120	120-lead Thin Quad Flat Package	Commercial
10	CY7C43682-10AC	A120	120-lead Thin Quad Flat Package	Commercial
15	CY7C43682-15AC	A120	120-lead Thin Quad Flat Package	Commercial
15	CY7C43682-15AI	A120	120-lead Thin Quad Flat Package	Industrial

Package Diagram

120-pin Thin Quad Flatpack (14 x 14 x 1.4 mm) A120

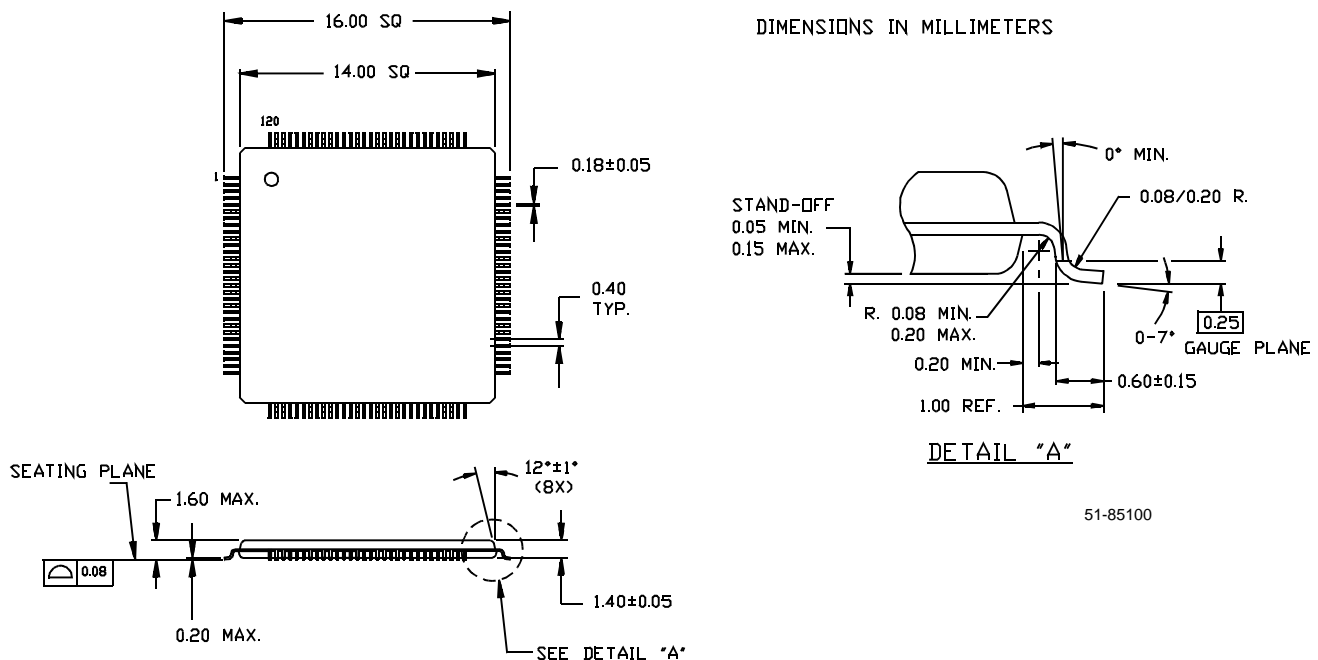

All product and company names mentioned in this document are the trademarks of their respective holders.



Document Title: CY7C43642, CY7C43662, CY7C43682 1K/4K/16K x36 x2 Bidirectional Synchronous FIFO
Document Number: 38-06019

REV.	ECN NO.	Issue Date	Orig. of Change	Description of Change
**	106556	06/08/01	SZV	Change from Spec #: 38-00698 to 38-06019
*A	117171	08/23/02	OOR	Added footnote to retransmit timing Added note to retransmit section
*B	122271	12/26/02	RBI	Power up requirements added to Maximum Ratings Information