

DATA SHEET

For a complete data sheet, please also download:

- The IC06 74HC/HCT/HCU/HCMOS Logic Family Specifications
- The IC06 74HC/HCT/HCU/HCMOS Logic Package Information
- The IC06 74HC/HCT/HCU/HCMOS Logic Package Outlines

74HC/HCT161

**Presettable synchronous 4-bit
binary counter; asynchronous reset**

Product specification
File under Integrated Circuits, IC06

December 1990

Presettable synchronous 4-bit binary counter; asynchronous reset

74HC/HCT161

FEATURES

- Synchronous counting and loading
- Two count enable inputs for n-bit cascading
- Positive-edge triggered clock
- Asynchronous reset
- Output capability: standard
- I_{CC} category: MSI

GENERAL DESCRIPTION

The 74HC/HCT161 are high-speed Si-gate CMOS devices and are pin compatible with low power Schottky TTL (LSTTL). They are specified in compliance with JEDEC standard no. 7A.

The 74HC/HCT161 are synchronous presettable binary counters which feature an internal look-ahead carry and can be used for high-speed counting. Synchronous operation is provided by having all flip-flops clocked simultaneously on the positive-going edge of the clock (CP). The outputs (Q₀ to Q₃) of the counters may be preset to a HIGH or LOW level. A LOW level at the parallel enable

input (\overline{PE}) disables the counting action and causes the data at the data inputs (D₀ to D₃) to be loaded into the counter on the positive-going edge of the clock (providing that the set-up and hold time requirements for \overline{PE} are met). Preset takes place regardless of the levels at count enable inputs (CEP and CET).

A LOW level at the master reset input (\overline{MR}) sets all four outputs of the flip-flops (Q₀ to Q₃) to LOW level regardless of the levels at CP, \overline{PE} , CET and CEP inputs (thus providing an asynchronous clear function).

The look-ahead carry simplifies serial cascading of the counters. Both count enable inputs (CEP and CET) must be HIGH to count. The CET input is fed forward to enable the terminal count output (TC). The TC output thus enabled will produce a HIGH output pulse of a duration approximately equal to a HIGH level output of Q₀. This pulse can be used to enable the next cascaded stage.

The maximum clock frequency for the cascaded counters is determined by the CP to TC propagation delay and CEP to CP set-up time, according to the following formula:

$$f_{max} = \frac{1}{t_{P(max)} (CP \text{ to } TC) + t_{SU} (CEP \text{ to } CP)}$$

QUICK REFERENCE DATA

GND = 0 V; T_{amb} = 25 °C; t_r = t_f = 6 ns

SYMBOL	PARAMETER	CONDITIONS	TYPICAL		UNIT
			HC	HCT	
t _{PHL} / t _{PLH}	propagation delay CP to Q _n CP to TC \overline{MR} to Q _n \overline{MR} to TC CET to TC	C _L = 15 pF; V _{CC} = 5 V	19	20	ns
			21	24	ns
			20	25	ns
			20	26	ns
			10	14	ns
f _{max}	maximum clock frequency		44	45	MHz
C _I	input capacitance		3.5	3.5	pF
C _{PD}	power dissipation capacitance per package	notes 1 and 2	33	35	pF

Notes

1. C_{PD} is used to determine the dynamic power dissipation (P_D in μW):

$$P_D = C_{PD} \times V_{CC}^2 \times f_i + \sum (C_L \times V_{CC}^2 \times f_o)$$
 where:
 f_i = input frequency in MHz
 f_o = output frequency in MHz
 Σ (C_L × V_{CC}² × f_o) = sum of outputs
 C_L = output load capacitance in pF
 V_{CC} = supply voltage in V
2. For HC the condition is
 V_I = GND to V_{CC}
 For HCT the condition is
 V_I = GND to V_{CC} - 1.5 V

Pre-settable synchronous 4-bit binary counter; asynchronous reset

74HC/HCT161

ORDERING INFORMATION

See "74HC/HCT/HCU/HCMOS Logic Package Information".

PIN DESCRIPTION

PIN NO.	SYMBOL	NAME AND FUNCTION
1	\overline{MR}	asynchronous master reset (active LOW)
2	CP	clock input (LOW-to-HIGH, edge-triggered)
3, 4, 5, 6	D ₀ to D ₃	data inputs
7	CEP	count enable input
8	GND	ground (0 V)
9	\overline{PE}	parallel enable input (active LOW)
10	CET	count enable carry input
14, 13, 12, 11	Q ₀ to Q ₃	flip-flop outputs
15	TC	terminal count output
16	V _{CC}	positive supply voltage

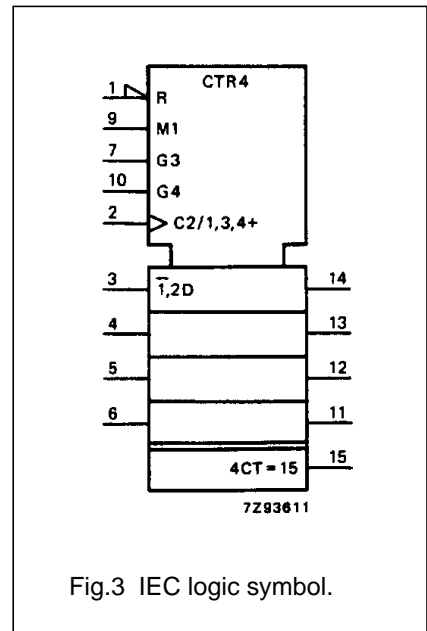
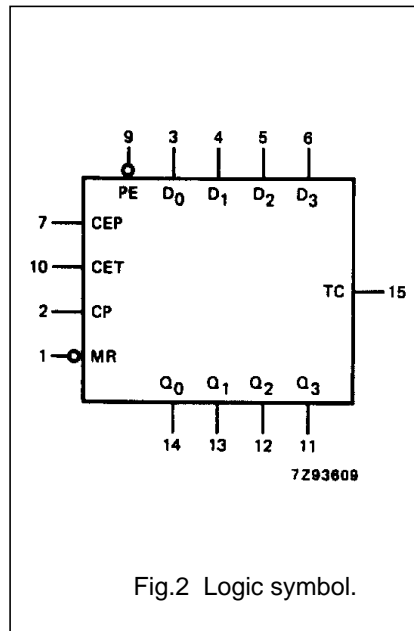
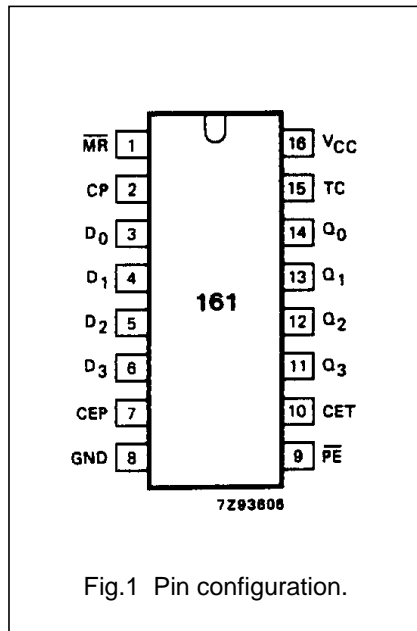

Pre-settable synchronous 4-bit binary counter; asynchronous reset

74HC/HCT161

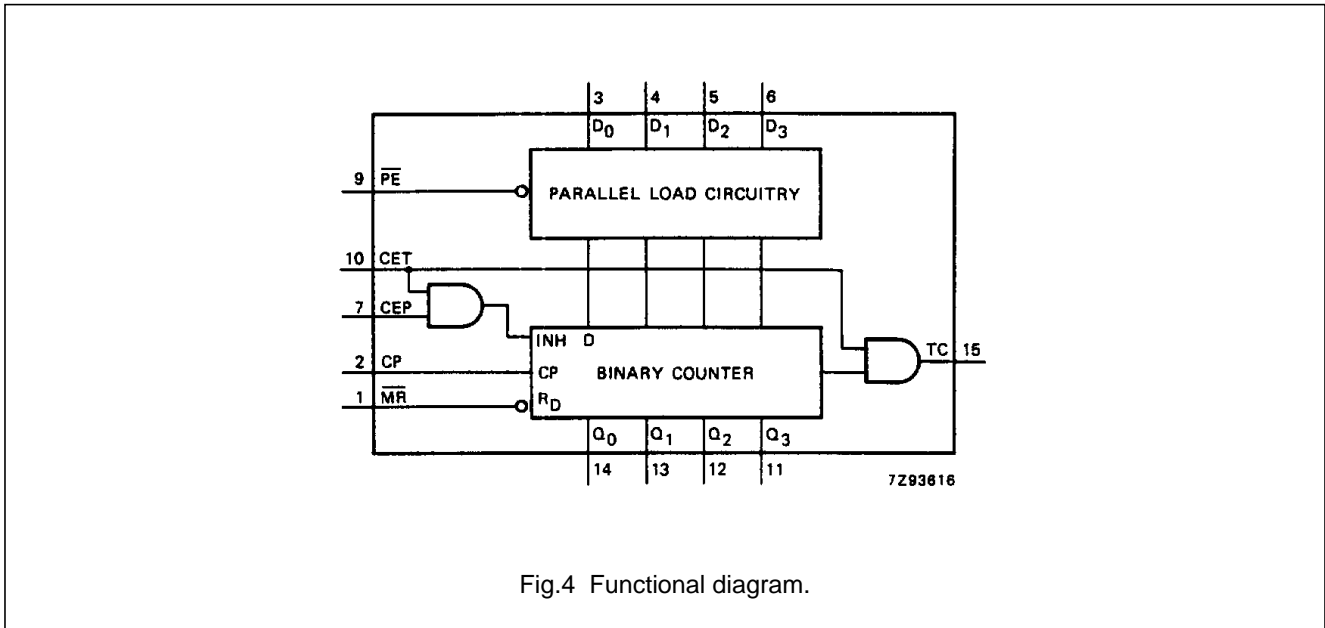

Fig.4 Functional diagram.

FUNCTION TABLE

OPERATING MODE	INPUTS						OUTPUTS	
	\overline{MR}	CP	CEP	CET	\overline{PE}	D_n	Q_n	TC
reset (clear)	L	X	X	X	X	X	L	L
parallel load	H	\uparrow	X	X	l	l	L	L
	H	\uparrow	X	X	l	h	H	(1)
count	H	\uparrow	h	h	h	X	count	(1)
hold (do nothing)	H	X	l	X	h	X	q_n	(1)
	H	X	X	l	h	X	q_n	L

Note

- The TC output is HIGH when CET is HIGH and the counter is at terminal count (HHHH).
 H = HIGH voltage level
 h = HIGH voltage level one set-up time prior to the LOW-to-HIGH CP transition
 L = LOW voltage level
 l = LOW voltage level one set-up time prior to the LOW-to-HIGH CP transition
 q = lower case letters indicate the state of the referenced output one set-up time prior to the LOW-to-HIGH CP transition
 X = don't care
 \uparrow = LOW-to-HIGH CP transition

Pre-settable synchronous 4-bit binary counter; asynchronous reset

74HC/HCT161

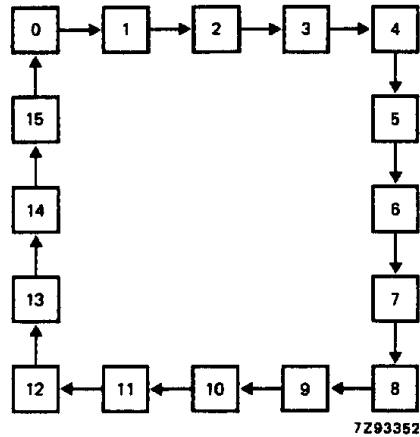

Fig.5 State diagram.

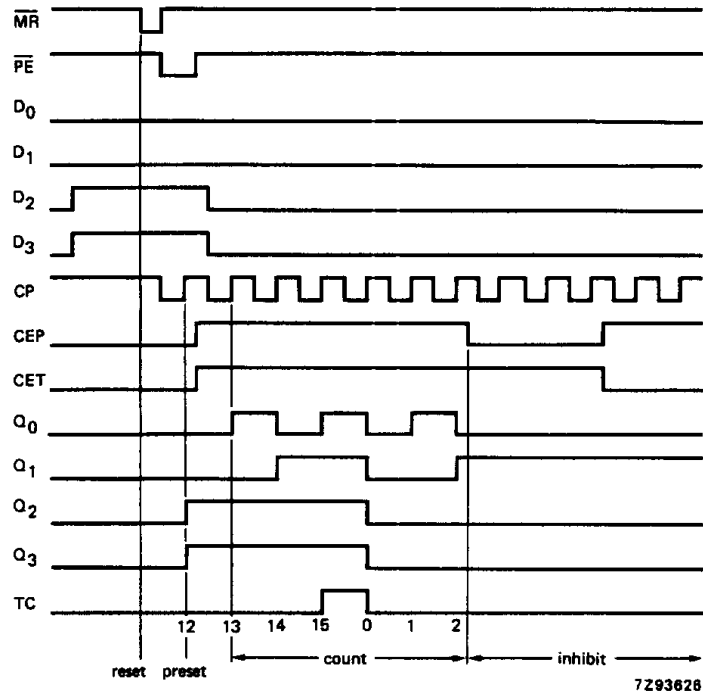
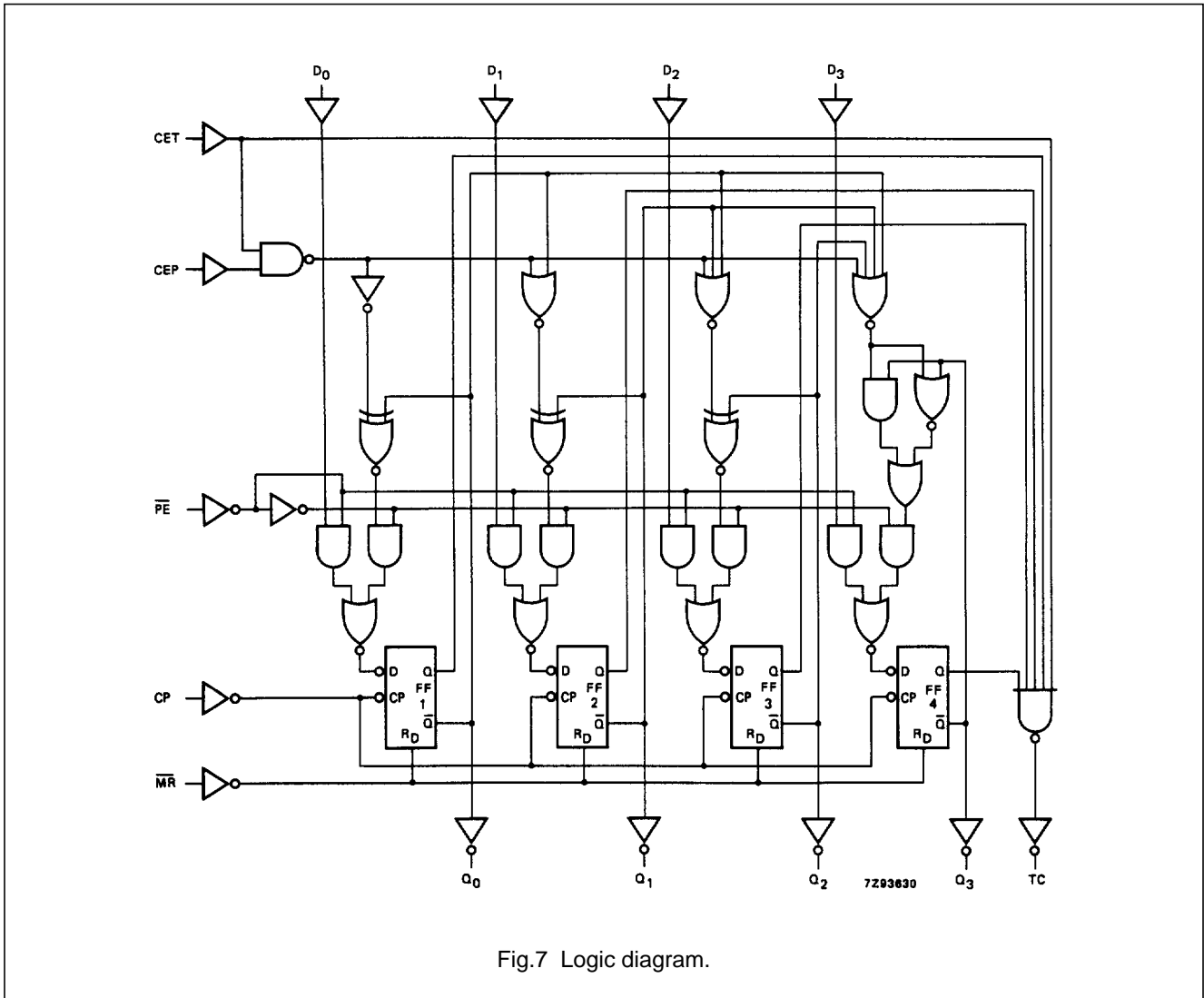

Fig.6 Typical timing sequence: reset outputs to zero; preset to binary twelve; count to thirteen, fourteen, fifteen, zero, one and two; inhibit.

Pre-settable synchronous 4-bit binary counter; asynchronous reset

74HC/HCT161



Presettable synchronous 4-bit binary counter; asynchronous reset

74HC/HCT161

DC CHARACTERISTICS FOR 74HC

For the DC characteristics see *"74HC/HCT/HCU/HCMOS Logic Family Specifications"*.

Output capability: standard

I_{CC} category: MSI

AC CHARACTERISTICS FOR 74HC

GND = 0 V; t_r = t_f = 6 ns; C_L = 50 pF

SYMBOL	PARAMETER	T _{amb} (°C)							UNIT	TEST CONDITIONS	
		74HC								V _{CC} (V)	WAVEFORMS
		+25			-40 to +85		-40 to +125				
		min.	typ.	max.	min.	max.	min.	max.			
t _{PHL} / t _{PLH}	propagation delay CP to Q _n		61 22 18	190 38 32		240 48 41		285 57 48	ns	2.0 4.5 6.0	Fig.8
t _{PHL} / t _{PLH}	propagation delay CP to TC		69 25 20	215 43 37		270 54 46		325 65 55	ns	2.0 4.5 6.0	Fig.8
t _{PHL}	propagation delay $\overline{\text{MR}}$ to Q _n		63 23 18	210 42 36		265 53 45		315 63 54	ns	2.0 4.5 6.0	Fig.9
t _{PHL}	propagation delay $\overline{\text{MR}}$ to TC		63 23 18	220 44 37		275 55 47		330 66 56	ns	2.0 4.5 6.0	Fig.9
t _{PHL} / t _{PLH}	propagation delay CET to TC		33 12 10	150 30 26		190 38 33		225 45 38	ns	2.0 4.5 6.0	Fig.10
t _{THL} / t _{TLH}	output transition time		19 7 6	75 15 13		95 19 16		110 22 19	ns	2.0 4.5 6.0	Figs 8 and 10
t _w	clock pulse width HIGH or LOW	80 16 14	22 8 6		100 20 17		120 24 20		ns	2.0 4.5 6.0	Fig.8
t _w	master reset pulse width; LOW	80 16 14	19 7 6		100 20 17		120 24 20		ns	2.0 4.5 6.0	Fig.9
t _{rem}	removal time $\overline{\text{MR}}$ to CP	100 20 17	19 7 6		125 25 21		150 30 26		ns	2.0 4.5 6.0	Fig.9
t _{su}	set-up time D _n to CP	80 16 14	25 9 7		100 20 17		120 24 20		ns	2.0 4.5 6.0	Fig.11
t _{su}	set-up time $\overline{\text{PE}}$ to CP	100 20 17	30 11 9		125 25 21		150 30 26		ns	2.0 4.5 6.0	Fig.11

Pre-settable synchronous 4-bit binary
counter; asynchronous reset

74HC/HCT161

SYMBOL	PARAMETER	T _{amb} (°C)							UNIT	TEST CONDITIONS	
		74HC								V _{CC} (V)	WAVEFORMS
		+25			-40 to +85		-40 to +125				
		min.	typ.	max.	min.	max.	min.	max.			
t _{su}	set-up time CEP, CET to CP	170 34 29	47 17 14		215 43 37		255 51 43		ns	2.0 4.5 6.0	Fig.12
t _h	hold time D _n , \overline{PE} , CEP, CET to CP	0 0 0	-14 -5 -4		0 0 0		0 0 0		ns	2.0 4.5 6.0	Figs 11 and 12
f _{max}	maximum clock pulse frequency	4.6 23 27	13 40 48		3.6 18 21		3.0 15 18		MHz	2.0 4.5 6.0	Fig.8

Presettable synchronous 4-bit binary counter; asynchronous reset

74HC/HCT161

DC CHARACTERISTICS FOR 74HCT

For the DC characteristics see *"74HC/HCT/HCU/HCMOS Logic Family Specifications"*.

Output capability: standard

I_{CC} category: MSI

Note to HCT types

The value of additional quiescent supply current (ΔI_{CC}) for a unit load of 1 is given in the family specifications. To determine ΔI_{CC} per input, multiply this value by the unit load coefficient shown in the table below.

INPUT	UNIT LOAD COEFFICIENT
\overline{MR}	0.95
CP	1.10
CEP	0.25
D _n	0.25
CET	0.75
\overline{PE}	0.30

AC CHARACTERISTICS FOR 74HCT

GND = 0 V; t_r = t_f = 6 ns; C_L = 50 pF

SYMBOL	PARAMETER	T _{amb} (°C)								UNIT	TEST CONDITIONS	
		74HCT									V _{CC} (V)	WAVEFORMS
		+25			-40 to +85		-40 to +125					
		min.	typ.	max.	min.	max.	min.	max.				
t _{PHL} / t _{PLH}	propagation delay CP to Q _n		23	43		54		65	ns	4.5	Fig.8	
t _{PHL} / t _{PLH}	propagation delay CP to TC		28	48		60		72	ns	4.5	Fig.8	
t _{PHL}	propagation delay \overline{MR} to Q _n		29	46		58		69	ns	4.5	Fig.9	
t _{PHL}	propagation delay MR to TC		30	51		64		77	ns	4.5	Fig.9	
t _{PHL} / t _{PLH}	propagation delay CET to TC		17	35		44		53	ns	4.5	Fig.10	
t _{THL} / t _{TLH}	output transition time		7	15		19		22	ns	4.5	Figs 8 and 10	
t _w	clock pulse width HIGH or LOW	16	7		20		24		ns	4.5	Fig.8	
t _w	master reset pulse width; LOW	20	10		25		30		ns	4.5	Fig.9	
t _{rem}	removal time MR to CP	20	6		25		30		ns	4.5	Fig.9	

Presettable synchronous 4-bit binary
counter; asynchronous reset

74HC/HCT161

SYMBOL	PARAMETER	T _{amb} (°C)							UNIT	TEST CONDITIONS	
		74HCT								V _{CC} (V)	WAVEFORMS
		+25			-40 to +85		-40 to +125				
		min.	typ.	max.	min.	max.	min.	max.			
t _{su}	set-up time D _n to CP	18	8		23		27		ns	4.5	Fig.11
t _{su}	set-up time \overline{PE} to CP	30	17		38		45		ns	4.5	Fig.11
t _{su}	set-up time CEP, CET to CP	40	17		50		60		ns	4.5	Fig.12
t _h	hold time D _n , \overline{PE} , CEP, CET to CP	0	-7		0		0		ns	4.5	Figs 11 and 12
f _{max}	maximum clock pulse frequency	23	41		18		15		MHz	4.5	Fig.8

Pre-settable synchronous 4-bit binary counter; asynchronous reset

74HC/HCT161

AC WAVEFORMS

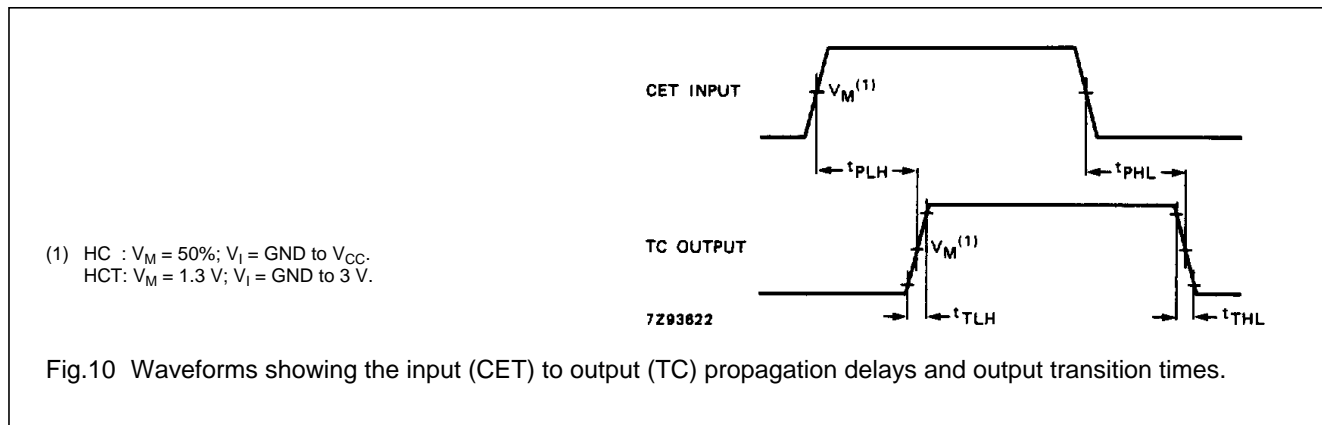
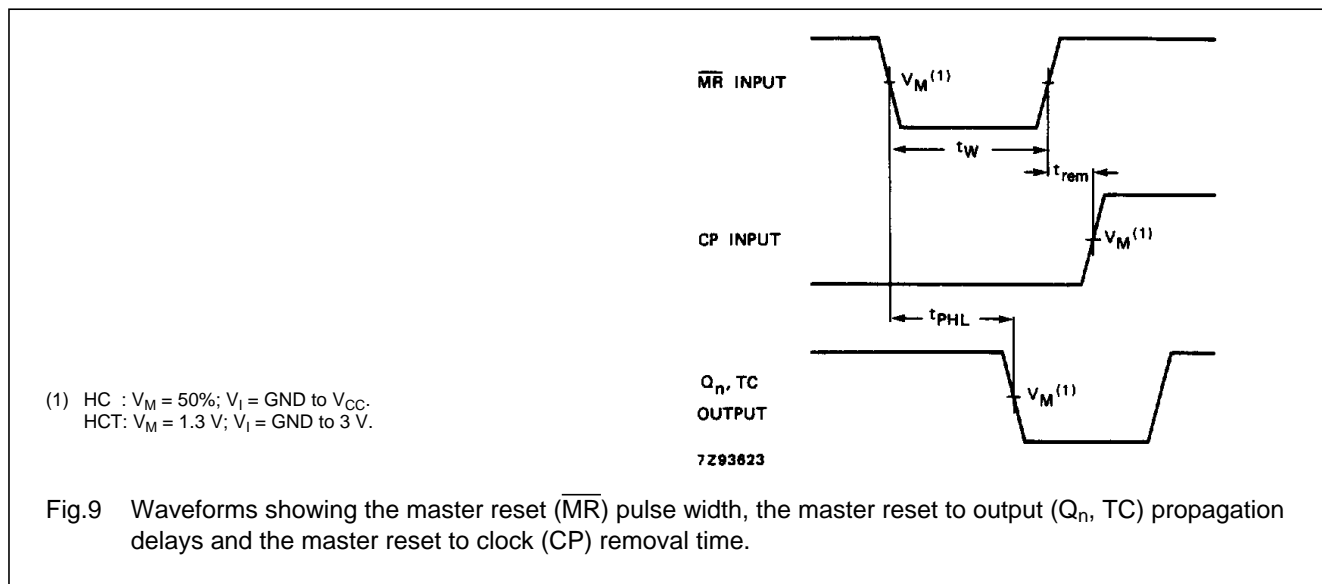
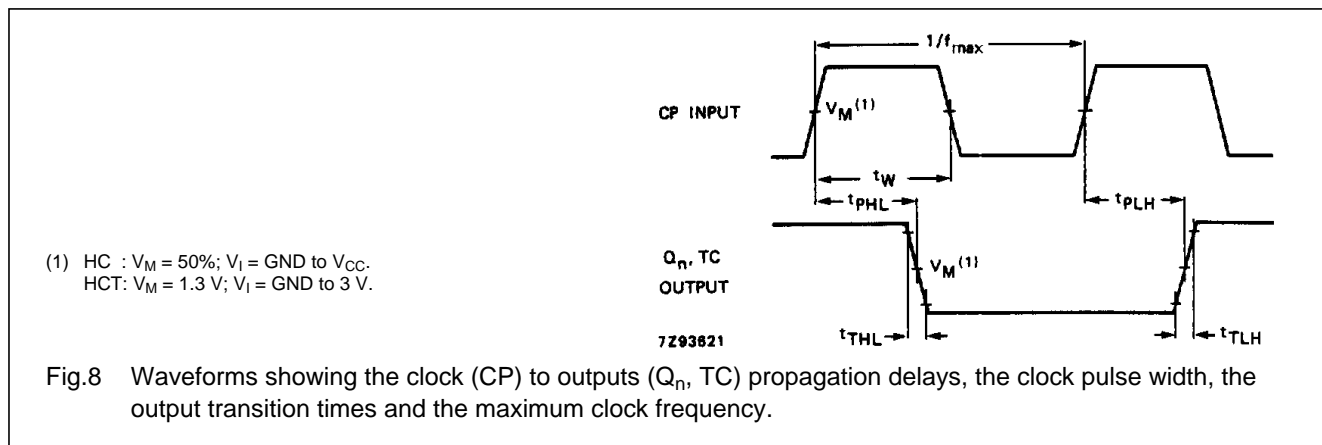

Presettable synchronous 4-bit binary counter; asynchronous reset

74HC/HCT161

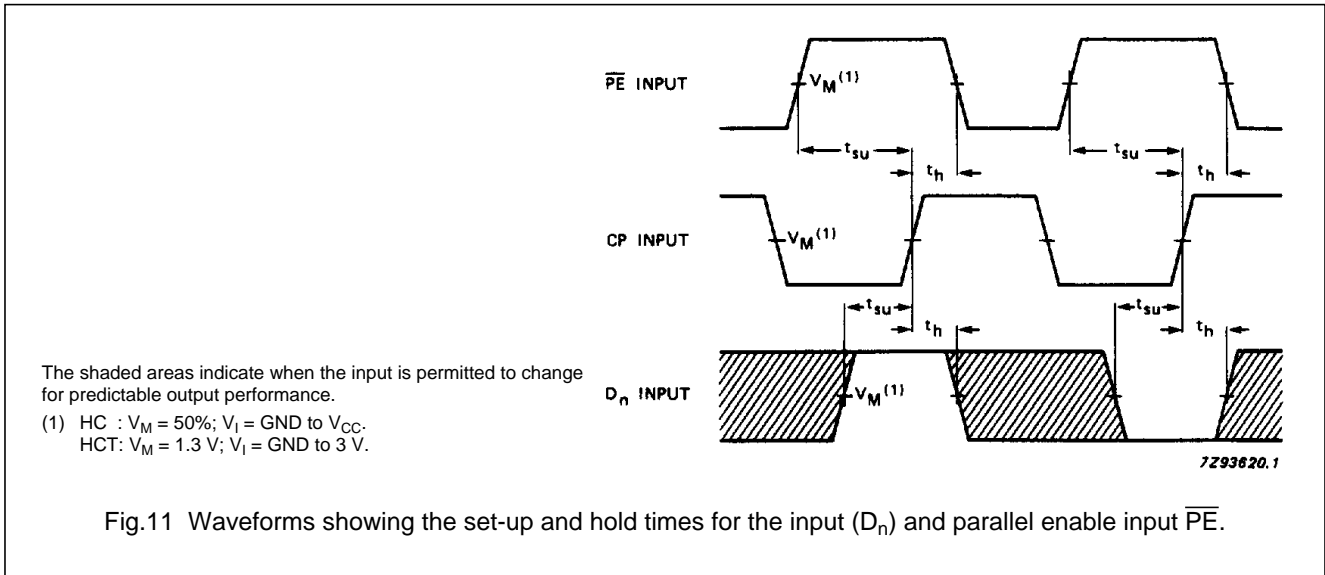

Fig.11 Waveforms showing the set-up and hold times for the input (D_n) and parallel enable input \overline{PE} .

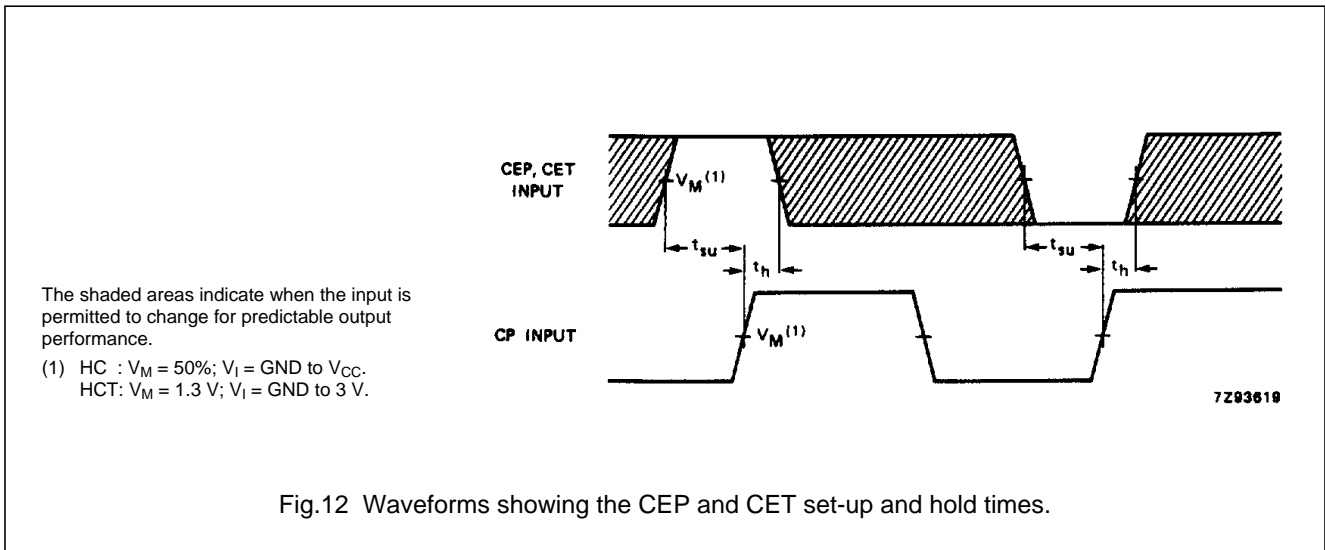

Fig.12 Waveforms showing the CEP and CET set-up and hold times.

PACKAGE OUTLINES

See "74HC/HCT/HCU/HCMOS Logic Package Outlines".

161 counters

Presetable Synchronous 4-Bit Binary Counters; Asynchronous Reset

 [Products](#)











 [More Info](#)

Products









Click  for **datasheet**. Also, see [datasheet disclaimer](#).

   indicate product status. Click  or  for more or less detail.

161 Counters

  74ALS16B 	Presetable Synchronous 4-Bit Binary Counter; Asynchronous Reset
  74F161A 	5V Presetable Synchronous 4-Bit Binary Counter; Asynchronous Reset
  74HC161 	5V Presetable Synchronous 4-Bit Binary Counter; Asynchronous Reset
  74HCT161 	5V Presetable Synchronous 4-Bit Binary Counter; Asynchronous Reset; TTL Enabled

- [Datasheet](#) (Dec 1, 1990)

74HCT161N	DIL-16	 Production	SOT38-4	 Pb-Free	MSL=1
74HCT161D	SO-16	 Production	SOT109-1	 Pb-Free	MSL=1
74HCT161DB	SSOP-16	 Production	SOT338-1	 Pb-Free	MSL=1
74HCT161PW	TSSOP-16	 Production	SOT403-1	 Pb-Free	MSL=1
74HCT161BQ	DQFN-16	Inquire	SOT763-1	 Pb-Free	MSL=1

[Family Functions](#) [Literature](#) [Models](#) [Support Docs](#) [Price](#) [Buy Online](#) [More...](#)

Standard ICs quick find

Standard ICs sections

 [Product families & functions](#)

 [Literature](#) brochures, leaflets, presentations

 [Support](#) manuals, models, FAQ, software, demoboards, tools, training

 [Packaging](#) specs & SOT #s

 [Quality](#) handbook, markings

 [Contact](#) sales, distributors

 **74LVC161**

 3.3V Presettable Synchronous 4-Bit Binary Counter; Asynchronous Reset

More Information

Links

 [Counters](#)

founded by

PHILIPS

161 counters

Presetable Synchronous 4-Bit Binary Counters; Asynchronous Reset

 [Products](#)

 [More Info](#)





Products



Click  for **datasheet**. Also, see [datasheet disclaimer](#).

   indicate product status. Click  or  for more or less detail.











161 Counters

  **74ALS16B**  Presetable Synchronous 4-Bit Binary Counter; Asynchronous Reset



   **74F161A**  5V Presetable Synchronous 4-Bit Binary Counter; Asynchronous Reset

   **74HC161** 5V Presetable Synchronous 4-Bit Binary Counter; Asynchronous Reset

-  [Datasheet](#) (Dec 1, 1990)

74HC161N	DIL-16	 Production	SOT38-4	 Pb-Free	MSL=1
74HC161D	SO-16	 Production	SOT109-1	 Pb-Free	MSL=1
74HC161DB	SSOP-16	 Production	SOT338-1	 Pb-Free	MSL=1
74HC161PW	TSSOP-16	 Production	SOT403-1	 Pb-Free	MSL=1
74HC161BQ	DQFN-16	 Inquire	SOT763-1	 Pb-Free	MSL=1

[Family](#) [Functions](#) [Literature](#) [Models](#) [Support](#) [Docs](#) [Price](#) [Buy Online](#) [More...](#)

   **74HCT161** 5V Presetable Synchronous 4-Bit Binary Counter; Asynchronous Reset; TTL Enabled

Standard ICs quick find

Standard ICs sections

 [Product](#) families & functions

 [Literature](#) brochures, leaflets, presentations

 [Support](#) manuals, models, FAQ, software, demoboards, tools, training

 [Packaging](#) specs & SOT #s

 [Quality](#) handbook, markings

 [Contact](#) sales, distributors

 **74LVC161**

 3.3V Presettable Synchronous 4-Bit Binary Counter; Asynchronous Reset

More Information

Links

 [Counters](#)

founded by

PHILIPS