

14A, 410V N-Channel, Logic Level, Voltage Clamping IGBTs

This N-Channel IGBT is a MOS gated, **logic level** device which is intended to be used as an ignition coil driver in **automotive ignition circuits**. Unique features include an active voltage clamp between the collector and the gate which provides **Self Clamped Inductive Switching (SCIS)** capability in ignition circuits. Internal diodes provide **ESD protection** for the logic level gate. Both a series resistor and a shunt resistor are provided in the gate circuit

Formerly Developmental Type TA49360.

Ordering Information

PART NUMBER	PACKAGE	BRAND
HGT1S14N41G3VLS	TO-263AB	14N41GVL
HGTP14N41G3VL	TO-220AB	14N41GVL

NOTE: When ordering, use the entire part number. Add the suffix 9A to obtain the TO-263AB in tape and reel, i.e. HGT1S14N41G3VLS9A

Symbol

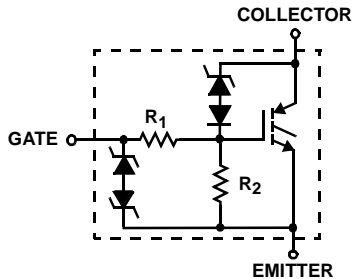

Features

- Ignition Energy = 340mJ at T_J (STARTING) = 25°C
- Typical Internal Clamp Voltage = 410V at T_J = 25°C
- Logic Level Gate Drive
- ESD Gate Protection
- T_J = 175°C
- Internal Series and Shunt Gate Resistors
- 24V Reverse Battery Capability
- Related Literature
 - TB334, "Guidelines for Soldering Surface Mount Components to PC Boards"

Packaging

JEDEC TO-263AB

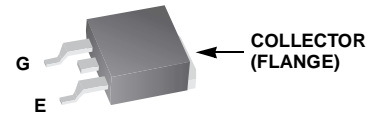

JEDEC TO-220AB

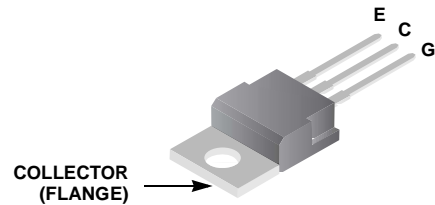

FAIRCHILD CORPORATION IGBT PRODUCT IS COVERED BY ONE OR MORE OF THE FOLLOWING U.S. PATENTS

4,364,073	4,417,385	4,430,792	4,443,931	4,466,176	4,516,143	4,532,534	4,587,713
4,598,461	4,605,948	4,620,211	4,631,564	4,639,754	4,639,762	4,641,162	4,644,637
4,682,195	4,684,413	4,694,313	4,717,679	4,743,952	4,783,690	4,794,432	4,801,986
4,803,533	4,809,045	4,809,047	4,810,665	4,823,176	4,837,606	4,860,080	4,883,767
4,888,627	4,890,143	4,901,127	4,904,609	4,933,740	4,963,951	4,969,027	

HGT1S14N41G3VLS, HGTP14N41G3VL

Absolute Maximum Ratings $T_C = 25^\circ\text{C}$, Unless Otherwise Specified

	HGT1S14N41G3VLS, HGTP14N41G3VL	UNITS
Collector to Emitter Breakdown Voltage	BV_{CER} 430	V
Collector to Emitter Breakdown Voltage	BV_{CES} 445	V
Emitter to Collector Breakdown Voltage	BV_{ECS} 24	V
Collector Current Continuous at $V_{GE} = 5\text{V}$, $T_C = 25^\circ\text{C}$	I_{C25} 25	A
at $V_{GE} = 5\text{V}$, $T_C = 110^\circ\text{C}$	I_{C110} 18	A
Gate to Emitter Voltage (Note 1)	V_{GEM} ± 10	V
Inductive Switching Current at $L = 3\text{ mH}$, $T_C = 25^\circ\text{C}$	I_{SCIS} 15	A
at $L = 3\text{ mH}$, $T_C = 150^\circ\text{C}$	I_{SCIS} 11.5	A
Collector to Emitter Avalanche Energy at $L = 3\text{ mH}$, $T_C = 25^\circ\text{C}$	E_{AS} 340	mJ
Power Dissipation Total at $T_C = 25^\circ\text{C}$	P_D 136	W
Power Dissipation Derating $T_C > 25^\circ\text{C}$	0.91	W/ $^\circ\text{C}$
Storage Junction Temperature Range	T_{STG} -55 to 175	$^\circ\text{C}$
Operating Junction Temperature Range	T_J -55 to 175	$^\circ\text{C}$
Electrostatic Discharge Voltage HBM at 250pF, 1500 Ω All Pin Configurations	ESD 5	kV
Electrostatic Discharge Voltage MM at 200pF, 0 Ω All Pin Configurations	ESD 2	kV
Maximum Lead Temperature for Soldering		
Leads at 0.063in (1.6mm) from Case for 10s.	T_L 300	$^\circ\text{C}$
Package Body for 10s, See Techbrief 334	T_{PKG} 260	$^\circ\text{C}$

CAUTION: Stresses above those listed in "Absolute Maximum Ratings" may cause permanent damage to the device. This is a stress only rating and operation of the device at these or any other conditions above those indicated in the operational sections of this specification is not implied.

NOTE:

1. May be exceeded if I_{GEM} is limited to 10mA.

Electrical Specifications $T_J = 25^\circ\text{C}$, Unless Otherwise Specified

PARAMETER	SYMBOL	TEST CONDITIONS	MIN	TYP	MAX	UNITS	
Collector to Emitter Breakdown Voltage	BV_{CER}	$I_C = 10\text{mA}$, $R_G = 1\text{k}\Omega$, $V_{GE} = 0\text{V}$, $T_J = -40^\circ\text{C}$ to 150°C (Figure 17)	380	410	430	V	
Collector to Emitter Breakdown Voltage	BV_{CES}	$I_C = 10\text{mA}$, $V_{GE} = 0\text{V}$, $T_J = -40^\circ\text{C}$ to 150°C	395	425	445	V	
Gate to Emitter Plateau Voltage	V_{GEP}	$I_C = 10\text{A}$, $V_{CE} = 12\text{V}$	-	3	-	V	
Gate Charge	$Q_{G(ON)}$	$I_C = 10\text{A}$, $V_{CE} = 12\text{V}$, $V_{GE} = 5\text{V}$ (Figure 16)	-	26	-	nC	
Collector to Emitter Clamp Breakdown Voltage	$BV_{CE(CL)}$	$I_C = 15\text{A}$, $R_G = 1\text{k}\Omega$	380	410	430	V	
Emitter to Collector Breakdown Voltage	BV_{ECS}	$I_C = 10\text{mA}$	24	28	-	V	
Collector to Emitter Leakage Current	I_{CES}	$V_{CE} = 350\text{V}$, $V_{GE} = 0\text{V}$ (Figure 13)	$T_J = 25^\circ\text{C}$	-	-	40	μA
			$T_J = 150^\circ\text{C}$	-	-	200	μA
		$V_{CE} = 15\text{V}$, $V_{GE} = 0\text{V}$	$T_J = 25^\circ\text{C}$	-	-	10	μA
			$T_J = 150^\circ\text{C}$	-	-	50	μA
Emitter to Collector Leakage Current	I_{ECS}	$V_{EC} = 24\text{V}$, $V_{GE} = 0\text{V}$ (Figure 13)	$T_J = 25^\circ\text{C}$	-	-	1	mA
			$T_J = 150^\circ\text{C}$	-	-	40	mA
Gate to Emitter Threshold Voltage	$V_{GE(TH)}$	$I_C = 1\text{mA}$, $V_{CE} = V_{GE}$ (Figure 12)	1.3	1.8	2.2	V	
Collector to Emitter On-State Voltage	$V_{CE(ON)}$	$I_C = 10\text{A}$, $V_{GE} = 3.7\text{V}$ (Figures 3 to 9)	$T_J = 25^\circ\text{C}$	-	1.6	2.65	V
			$T_J = 150^\circ\text{C}$	-	1.7	2.75	V
Collector to Emitter On-State Voltage	$V_{CE(ON)}$	$I_C = 6\text{A}$, $V_{GE} = 4.0\text{V}$ (Figures 3 to 9)	$T_J = -40^\circ\text{C}$	-	1.3	1.7	V
			$T_J = 25^\circ\text{C}$	-	1.25	1.6	V
		$I_C = 10\text{A}$, $V_{GE} = 4.5\text{V}$ (Figures 3 to 9)	$T_J = 25^\circ\text{C}$	-	1.45	1.7	V
			$T_J = 150^\circ\text{C}$	-	1.55	1.8	V
		$I_C = 14\text{A}$, $V_{GE} = 5\text{V}$ (Figures 3 to 9)	$T_J = 25^\circ\text{C}$	-	1.65	2.0	V
			$T_J = 175^\circ\text{C}$	-	1.8	2.3	V
Gate Series Resistance	R_1		-	80	-	Ω	
Gate to Emitter Resistance	R_2		10	18	26	k Ω	

HGT1S14N41G3VLS, HGTP14N41G3VL

Electrical Specifications $T_J = 25^\circ\text{C}$, Unless Otherwise Specified (Continued)

PARAMETER	SYMBOL	TEST CONDITIONS	MIN	TYP	MAX	UNITS	
Gate to Emitter Leakage Current	I_{GES}	$V_{GE} = \pm 10\text{V}$	± 384	± 555	± 1000	μA	
Gate to Emitter Breakdown Voltage	BV_{GES}	$I_{GES} = \pm 5\text{mA}$	± 12	± 14	-	V	
Current Turn-On Delay Time - Resistive Load	$t_{d(ON)I}$	$V_{DD} = 14\text{V}$, $R_G = 1\text{k}\Omega$, $V_{GE} = 5\text{V}$ (Figure 14)	$I_C = 11.5\text{A}$, $T_J = 25^\circ\text{C}$	-	0.9	1.5	μs
			$I_C = 6.5\text{A}$, $T_J = 150^\circ\text{C}$	-	0.75	1.6	μs
Current Turn-On Rise Time - Resistive Load	t_{rI}	$V_{DD} = 14\text{V}$, $R_G = 1\text{k}\Omega$, $V_{GE} = 5\text{V}$ (Figure 14)	$I_C = 11.5\text{A}$, $T_J = 25^\circ\text{C}$	-	3.2	4.5	μs
			$I_C = 6.5\text{A}$, $T_J = 150^\circ\text{C}$	-	2.7	3.8	μs
Current Turn-Off Time - Inductive Load	$t_{d(OFF)I} + t_{fI}$	$I_C = 6.5\text{A}$, $R_G = 1\text{k}\Omega$, $V_{GE} = 5\text{V}$, $L = 300\mu\text{H}$, $V_{DD} = 300\text{V}$, $T_J = 150^\circ\text{C}$ (Figure 14)	-	9	20	μs	
Current Turn-Off Time - Resistive Load	$t_{d(OFF)I} + t_{fI}$	$I_C = 6.5\text{A}$, $R_G = 1\text{k}\Omega$, $V_{GE} = 5\text{V}$, $R_L = 46\Omega$, $V_{DD} = 300\text{V}$, $T_J = 25^\circ\text{C}$ (Figure 14)	-	10	15	μs	
Inductive Use Test	I_{SCIS}	$L = 3\text{mH}$, $V_G = 5\text{V}$, $R_G = 1\text{k}\Omega$ (Figures 1, 2)	$T_C = 150^\circ\text{C}$	11.5	-	-	A
			$T_C = 25^\circ\text{C}$	15	-	-	A
Thermal Resistance	$R_{\theta JC}$	(Figure 18)	-	-	1.1	$^\circ\text{C/W}$	

Typical Performance Curves Unless Otherwise Specified

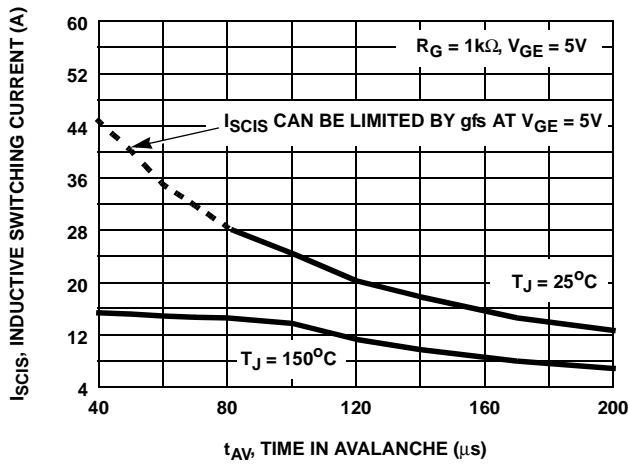

FIGURE 1. SELF CLAMPED INDUCTIVE SWITCHING CURRENT vs TIME IN AVALANCHE

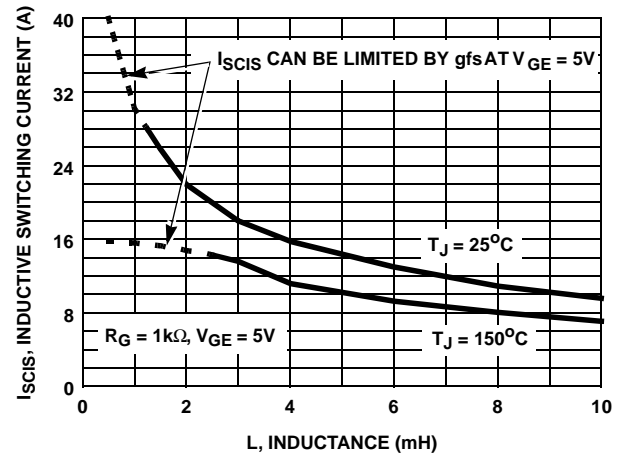

FIGURE 2. SELF CLAMPED INDUCTIVE SWITCHING CURRENT vs. INDUCTANCE

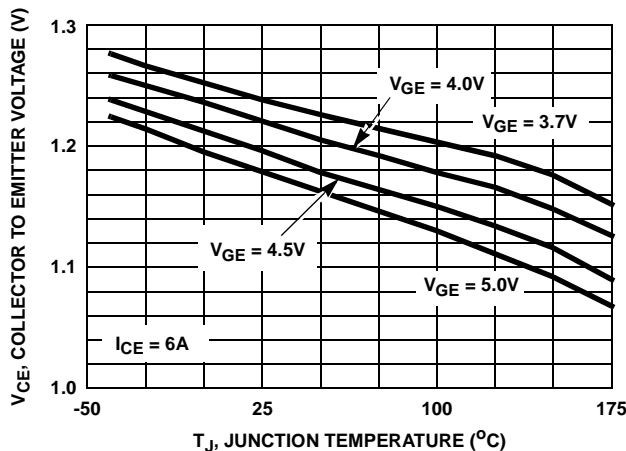

FIGURE 3. COLLECTOR TO EMITTER ON-STATE VOLTAGE vs JUNCTION TEMPERATURE

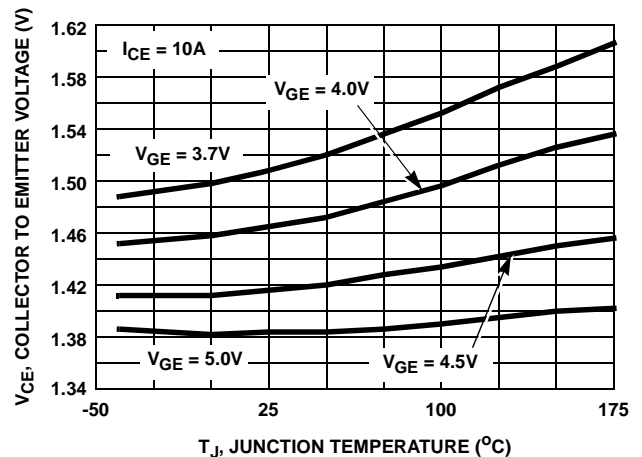

FIGURE 4. COLLECTOR TO EMITTER ON-STATE VOLTAGE vs JUNCTION TEMPERATURE

Typical Performance Curves Unless Otherwise Specified (Continued)

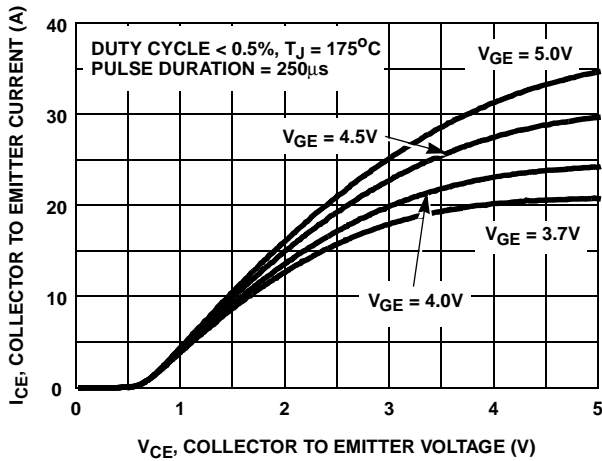

FIGURE 5. COLLECTOR TO EMITTER ON-STATE VOLTAGE

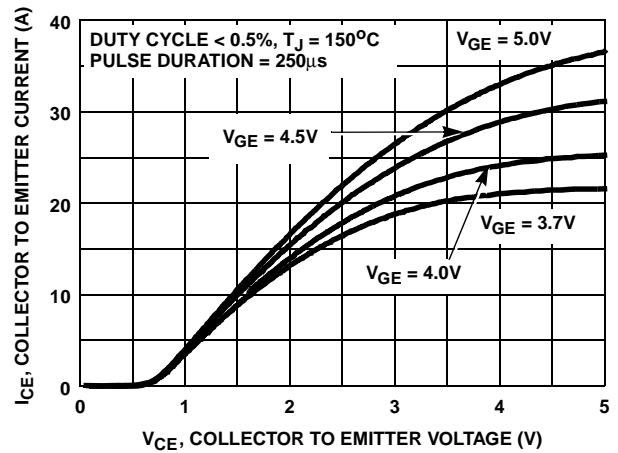

FIGURE 6. COLLECTOR TO EMITTER ON-STATE VOLTAGE

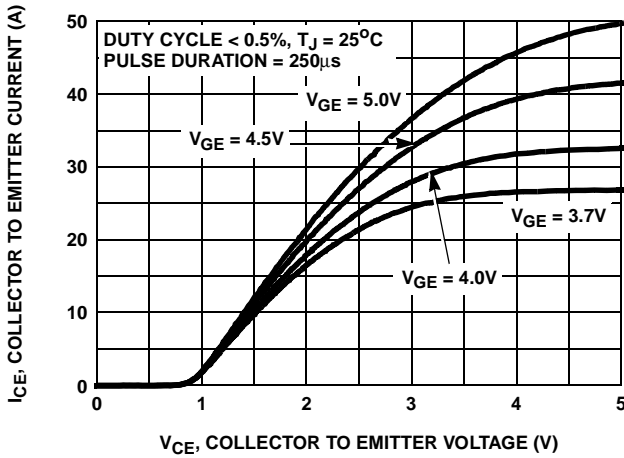

FIGURE 7. COLLECTOR TO EMITTER ON-STATE VOLTAGE

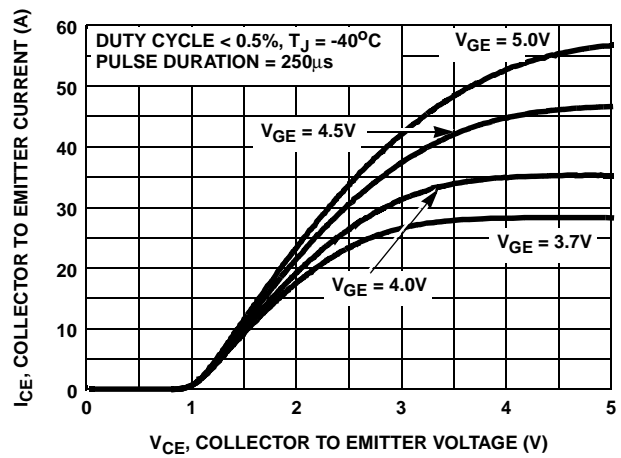

FIGURE 8. COLLECTOR TO EMITTER ON-STATE VOLTAGE

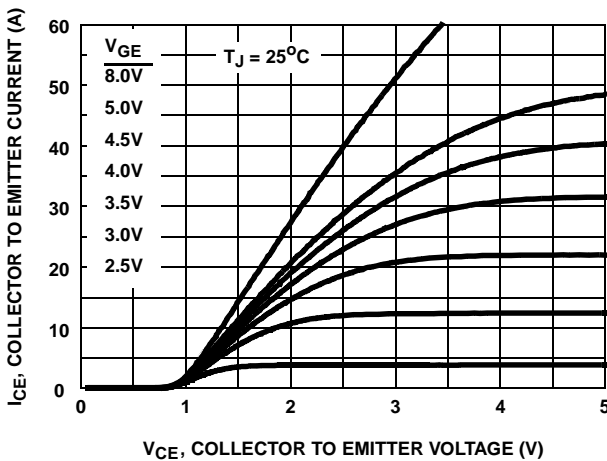

FIGURE 9. COLLECTOR TO EMITTER ON-STATE VOLTAGE

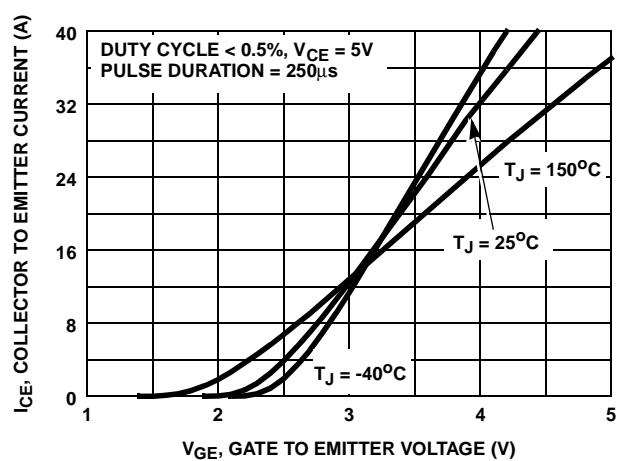

FIGURE 10. TRANSFER CHARACTERISTIC

Typical Performance Curves Unless Otherwise Specified (Continued)

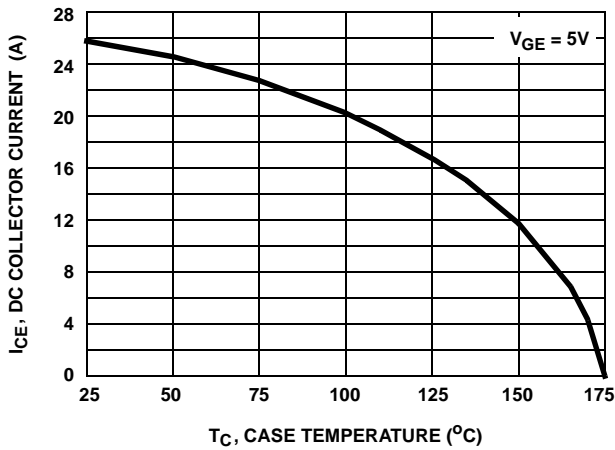

FIGURE 11. DC COLLECTOR CURRENT vs CASE TEMPERATURE

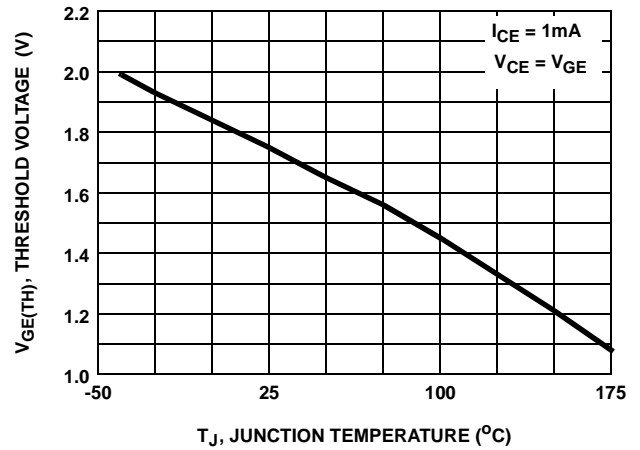

FIGURE 12. THRESHOLD VOLTAGE vs JUNCTION TEMPERATURE

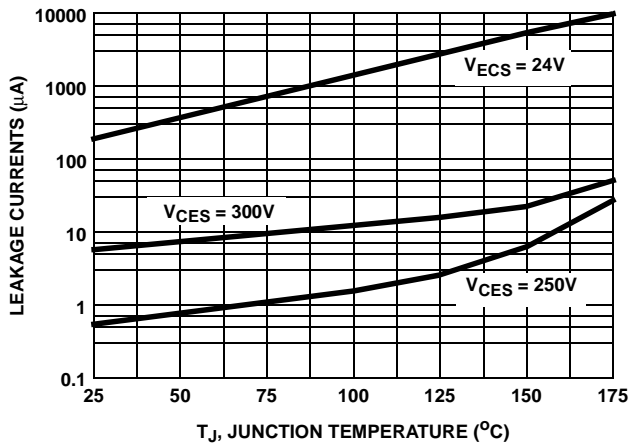

FIGURE 13. LEAKAGE CURRENT vs JUNCTION TEMPERATURE

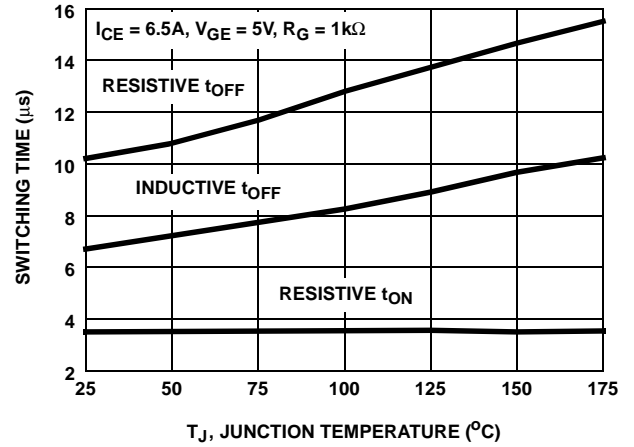

FIGURE 14. SWITCHING TIME vs JUNCTION TEMPERATURE

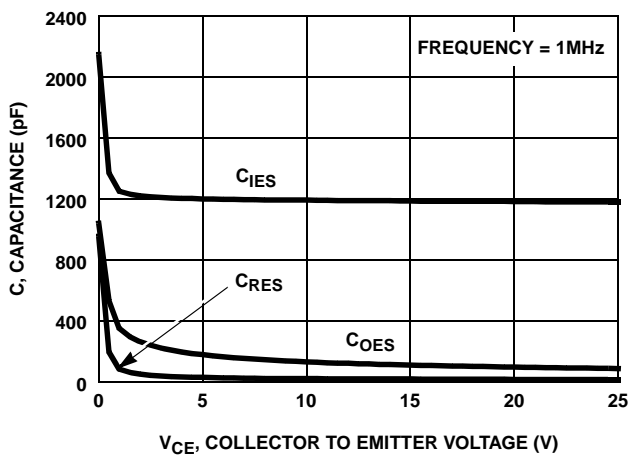

FIGURE 15. CAPACITANCE vs COLLECTOR TO EMITTER VOLTAGE

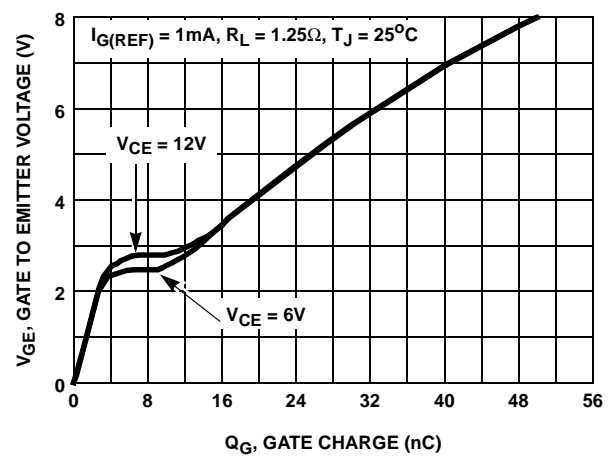

FIGURE 16. GATE CHARGE WAVEFORMS

Typical Performance Curves Unless Otherwise Specified (Continued)

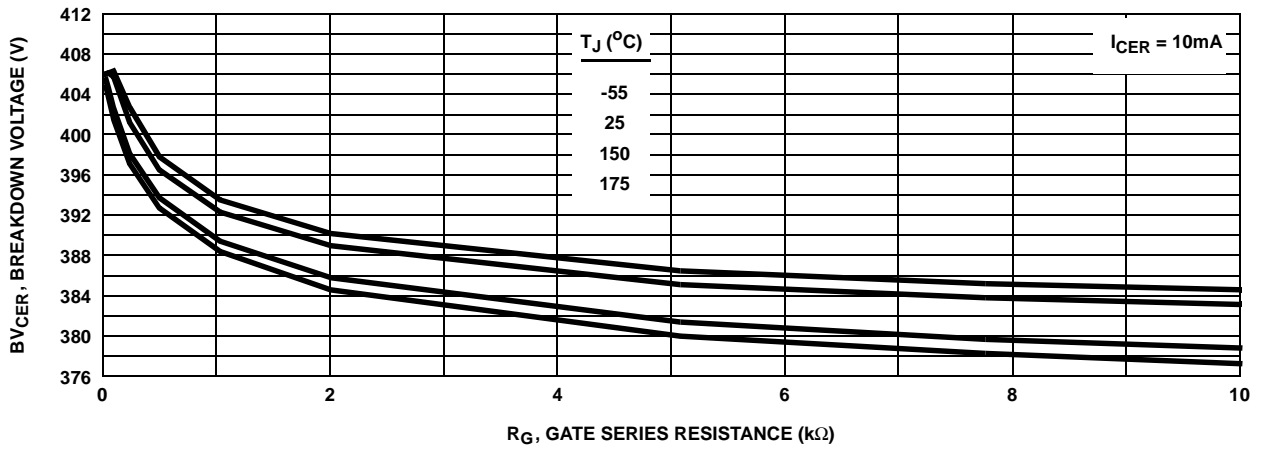

FIGURE 17. BREAKDOWN VOLTAGE vs SERIES GATE RESISTANCE

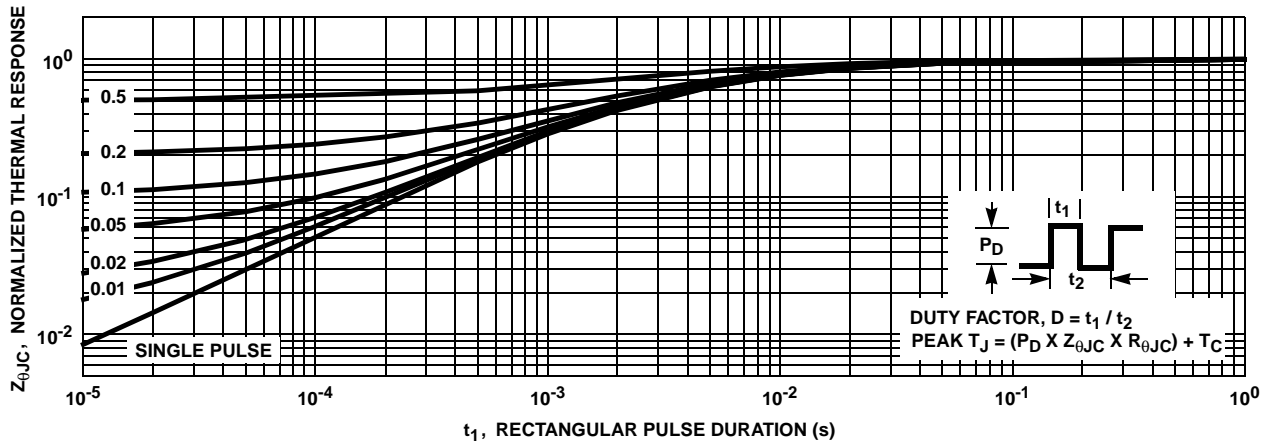

FIGURE 18. IGBT NORMALIZED TRANSIENT THERMAL RESPONSE, JUNCTION TO CASE

Test Circuit and Waveforms

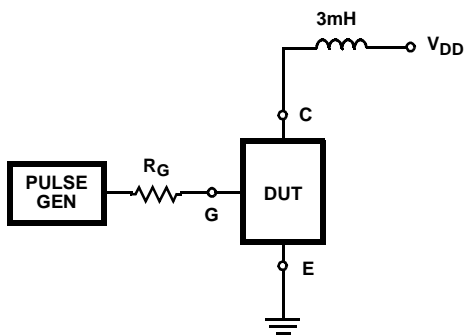

FIGURE 19. INDUCTIVE SWITCHING TEST CIRCUIT

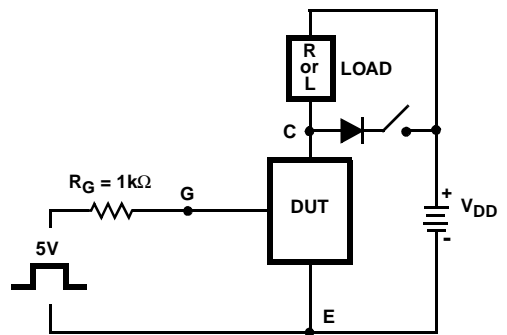

FIGURE 20. t_{ON} AND t_{OFF} SWITCHING TEST CIRCUIT