

# Amplifier Transistors

## NPN Silicon

**BC237,A,B,C**  
**BC238B,C**  
**BC239C**

### MAXIMUM RATINGS

Rating	Symbol	BC237	BC238	BC239	Unit
Collector–Emitter Voltage	$V_{CEO}$	45	25	25	Vdc
Collector–Emitter Voltage	$V_{CES}$	50	30	30	Vdc
Emitter–Base Voltage	$V_{EBO}$	6.0	5.0	5.0	Vdc
Collector Current — Continuous	$I_C$	100			mAdc
Total Device Dissipation @ $T_A = 25^\circ\text{C}$ Derate above $25^\circ\text{C}$	$P_D$	350			mW
		2.8			mW/ $^\circ\text{C}$
Total Device Dissipation @ $T_C = 25^\circ\text{C}$ Derate above $25^\circ\text{C}$	$P_D$	1.0			Watts
		8.0			mW/ $^\circ\text{C}$
Operating and Storage Junction Temperature Range	$T_J, T_{stg}$	–55 to +150			$^\circ\text{C}$

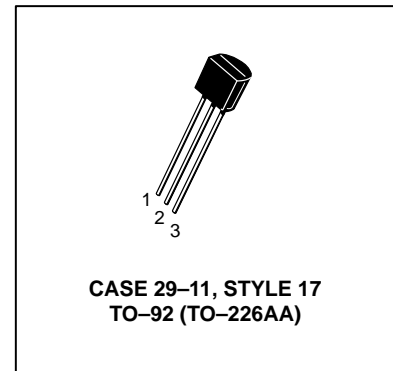

### THERMAL CHARACTERISTICS

Characteristic	Symbol	Max	Unit
Thermal Resistance, Junction to Ambient	$R_{\theta JA}$	357	$^\circ\text{C}/\text{W}$
Thermal Resistance, Junction to Case	$R_{\theta JC}$	125	$^\circ\text{C}/\text{W}$

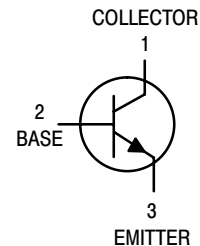

### ELECTRICAL CHARACTERISTICS ( $T_A = 25^\circ\text{C}$ unless otherwise noted)

Characteristic	Symbol	Min	Typ	Max	Unit
----------------	--------	-----	-----	-----	------

### OFF CHARACTERISTICS

Collector–Emitter Breakdown Voltage ( $I_C = 2.0\text{ mA}, I_B = 0$ )	BC237 BC238 BC239	$V_{(BR)CEO}$	45 25 25	— — —	— — —	V
Emitter–Base Breakdown Voltage ( $I_E = 100\ \mu\text{A}, I_C = 0$ )	BC237 BC238 BC239	$V_{(BR)EBO}$	6.0 5.0 5.0	— — —	— — —	V
Collector Cutoff Current ( $V_{CE} = 30\text{ V}, V_{BE} = 0$ )	BC238 BC239	$I_{CES}$	— —	0.2 0.2	15 15	nA
( $V_{CE} = 50\text{ V}, V_{BE} = 0$ )	BC237		—	0.2	15	
( $V_{CE} = 30\text{ V}, V_{BE} = 0$ ) $T_A = 125^\circ\text{C}$	BC238 BC239		— —	0.2 0.2	4.0 4.0	$\mu\text{A}$
( $V_{CE} = 50\text{ V}, V_{BE} = 0$ ) $T_A = 125^\circ\text{C}$	BC237		—	0.2	4.0	

## BC237,A,B,C BC238B,C BC239C

### ELECTRICAL CHARACTERISTICS ( $T_A = 25^\circ\text{C}$ unless otherwise noted) (Continued)

Characteristic	Symbol	Min	Typ	Max	Unit	
<b>ON CHARACTERISTICS</b>						
DC Current Gain ( $I_C = 10\ \mu\text{A}$ , $V_{CE} = 5.0\ \text{V}$ )	BC237A	—	90	—	—	
	BC237B/238B	—	150	—	—	
	BC237C/238C/239C	—	270	—	—	
( $I_C = 2.0\ \text{mA}$ , $V_{CE} = 5.0\ \text{V}$ )	BC237	120	—	800	—	
	BC237A	120	170	220	—	
	BC237B/238B	200	290	460	—	
	BC237C/238C/239C	380	500	800	—	
( $I_C = 100\ \text{mA}$ , $V_{CE} = 5.0\ \text{V}$ )	BC237A	—	120	—	—	
	BC237B/238B	—	180	—	—	
	BC237C/238C/239C	—	300	—	—	
Collector–Emitter On Voltage ( $I_C = 10\ \text{mA}$ , $I_B = 0.5\ \text{mA}$ ) ( $I_C = 100\ \text{mA}$ , $I_B = 5.0\ \text{mA}$ )	BC237/BC238/BC239	—	0.07	0.2	V	
	BC237/BC239	—	0.2	0.6	V	
	BC238	—	—	0.8	V	
Base–Emitter Saturation Voltage ( $I_C = 10\ \text{mA}$ , $I_B = 0.5\ \text{mA}$ ) ( $I_C = 100\ \text{mA}$ , $I_B = 5.0\ \text{mA}$ )		—	0.6	0.83	V	
		—	—	1.05	V	
Base–Emitter On Voltage ( $I_C = 100\ \mu\text{A}$ , $V_{CE} = 5.0\ \text{V}$ ) ( $I_C = 2.0\ \text{mA}$ , $V_{CE} = 5.0\ \text{V}$ ) ( $I_C = 100\ \text{mA}$ , $V_{CE} = 5.0\ \text{V}$ )		—	0.5	—	V	
		0.55	0.62	0.7	V	
		—	0.83	—	V	
		—	—	—	V	
<b>DYNAMIC CHARACTERISTICS</b>						
Current–Gain — Bandwidth Product ( $I_C = 0.5\ \text{mA}$ , $V_{CE} = 3.0\ \text{V}$ , $f = 100\ \text{MHz}$ )	BC237	—	100	—	MHz	
	BC238	—	120	—	MHz	
	BC239	—	140	—	MHz	
	( $I_C = 10\ \text{mA}$ , $V_{CE} = 5.0\ \text{V}$ , $f = 100\ \text{MHz}$ )	BC237	150	200	—	MHz
		BC238	150	240	—	MHz
		BC239	150	280	—	MHz
Collector–Base Capacitance ( $V_{CB} = 10\ \text{V}$ , $I_C = 0$ , $f = 1.0\ \text{MHz}$ )	$C_{obo}$	—	—	4.5	pF	
Emitter–Base Capacitance ( $V_{EB} = 0.5\ \text{V}$ , $I_C = 0$ , $f = 1.0\ \text{MHz}$ )	$C_{ibo}$	—	8.0	—	pF	
Noise Figure ( $I_C = 0.2\ \text{mA}$ , $V_{CE} = 5.0\ \text{V}$ , $R_S = 2.0\ \text{k}\Omega$ , $f = 1.0\ \text{kHz}$ )	BC239	—	2.0	4.0	dB	
	( $I_C = 0.2\ \text{mA}$ , $V_{CE} = 5.0\ \text{V}$ , $R_S = 2.0\ \text{k}\Omega$ , $f = 1.0\ \text{kHz}$ , $\Delta f = 200\ \text{Hz}$ )	BC237	—	2.0	10	dB
		BC238	—	2.0	10	dB
		BC239	—	2.0	4.0	dB
			—	—	—	dB

BC237,A,B,C BC238B,C BC239C

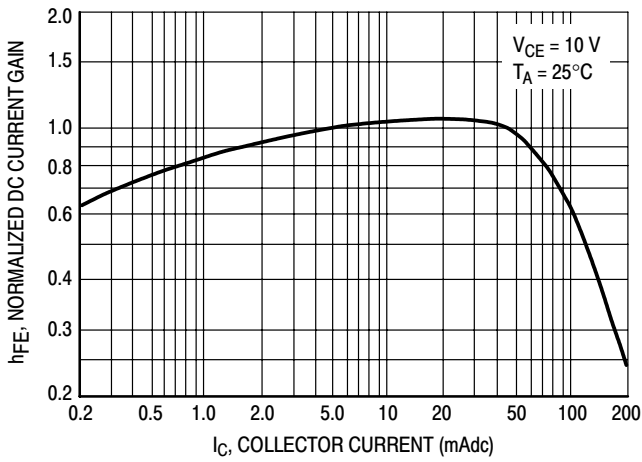

Figure 1. Normalized DC Current Gain

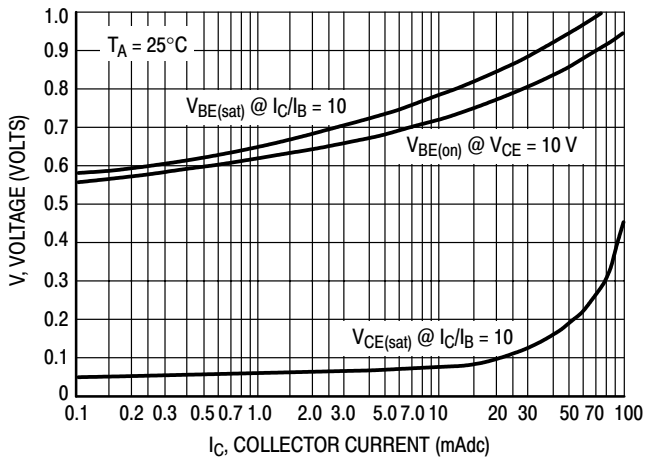

Figure 2. "Saturation" and "On" Voltages

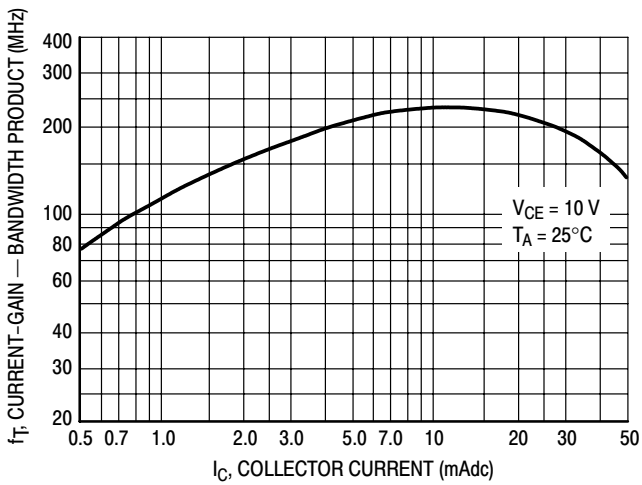

Figure 3. Current-Gain — Bandwidth Product

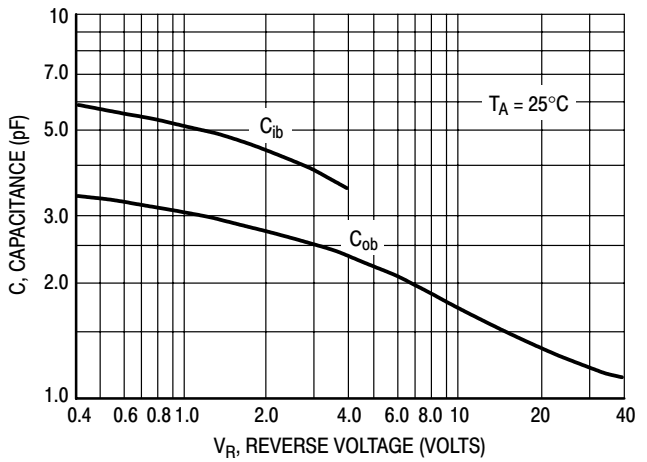

Figure 4. Capacitances

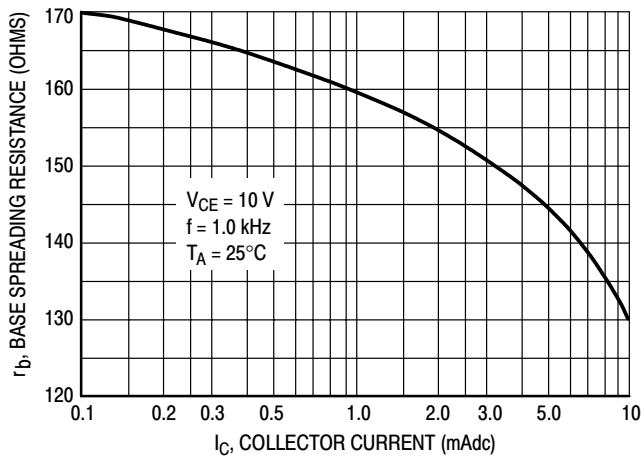

Figure 5. Base Spreading Resistance