

## FEATURES

- ◆ Avalanche Rugged Technology
- ◆ Rugged Gate Oxide Technology
- ◆ Lower Input Capacitance
- ◆ Improved Gate Charge
- ◆ Extended Safe Operating Area
- ◆ Lower Leakage Current: 10µA (Max.) @  $V_{DS} = 100V$
- ◆ Lower  $R_{DS(ON)}$ : 0.046Ω (Typ.)

$$BV_{DSS} = 100 V$$

$$R_{DS(on)} = 0.058\Omega$$

$$I_D = 28 A$$

TO-220

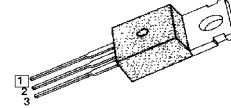

1. Gate 2. Drain 3. Source

## Absolute Maximum Ratings

Symbol	Characteristic	Value	Units
$V_{DSS}$	Drain-to-Source Voltage	100	V
$I_D$	Continuous Drain Current ( $T_C=25^\circ C$ )	28	A
	Continuous Drain Current ( $T_C=100^\circ C$ )	19.8	
$I_{DM}$	Drain Current-Pulsed (1)	98	A
$V_{GS}$	Gate-to-Source Voltage	$\pm 20$	V
$E_{AS}$	Single Pulsed Avalanche Energy (2)	522	mJ
$I_{AR}$	Avalanche Current (1)	28	A
$E_{AR}$	Repetitive Avalanche Energy (1)	12.1	mJ
dv/dt	Peak Diode Recovery dv/dt (3)	6.5	V/ns
$P_D$	Total Power Dissipation ( $T_C=25^\circ C$ )	121	W
	Linear Derating Factor	0.81	
$T_J, T_{STG}$	Operating Junction and Storage Temperature Range	- 55 to +175	$^\circ C$
$T_L$	Maximum Lead Temp. for Soldering Purposes, 1/8. from case for 5-seconds	300	

## Thermal Resistance

Symbol	Characteristic	Typ.	Max.	Units
$R_{\theta JC}$	Junction-to-Case	--	1.24	$^\circ C/W$
$R_{\theta CS}$	Case-to-Sink	0.5	--	
$R_{\theta JA}$	Junction-to-Ambient	--	62.5	

**FAIRCHILD**  
SEMICONDUCTOR™

©1999 Fairchild Semiconductor Corporation

Rev. B

### Electrical Characteristics ( $T_C=25^\circ\text{C}$ unless otherwise specified)

Symbol	Characteristic	Min.	Typ.	Max.	Units	Test Condition
$BV_{DSS}$	Drain-Source Breakdown Voltage	100	--	--	V	$V_{GS}=0V, I_D=250\mu A$
$\Delta BV/\Delta T_J$	Breakdown Voltage Temp. Coeff.	--	0.1	--	V/°C	$I_D=250\mu A$ <b>See Fig 7</b>
$V_{GS(th)}$	Gate Threshold Voltage	1.0	--	2.0	V	$V_{DS}=5V, I_D=250\mu A$
$I_{GSS}$	Gate-Source Leakage, Forward	--	--	100	nA	$V_{GS}=20V$
	Gate-Source Leakage, Reverse	--	--	-100		$V_{GS}=-20V$
$I_{DSS}$	Drain-to-Source Leakage Current	--	--	10	$\mu A$	$V_{DS}=100V$
		--	--	100		$V_{DS}=80V, T_C=150^\circ\text{C}$
$R_{DS(on)}$	Static Drain-Source On-State Resistance	--	--	0.058	$\Omega$	$V_{GS}=5V, I_D=14A$ (4)
$g_{fs}$	Forward Transconductance	--	22	--	$\bar{O}$	$V_{DS}=40V, I_D=14A$ (4)
$C_{iss}$	Input Capacitance	--	1215	1580	pF	$V_{GS}=0V, V_{DS}=25V, f=1\text{MHz}$ <b>See Fig 5</b>
$C_{oss}$	Output Capacitance	--	310	390		
$C_{rss}$	Reverse Transfer Capacitance	--	145	180		
$t_{d(on)}$	Turn-On Delay Time	--	7	25	ns	$V_{DD}=50V, I_D=28A,$ $R_G=4.6\Omega$ <b>See Fig 13</b> (4) (5)
$t_r$	Rise Time	--	12	35		
$t_{d(off)}$	Turn-Off Delay Time	--	38	85		
$t_f$	Fall Time	--	24	60		
$Q_g$	Total Gate Charge	--	38.4	54	nC	$V_{DS}=80V, V_{GS}=5V,$ $I_D=28A$ <b>See Fig 6 &amp; Fig 12</b> (4) (5)
$Q_{gs}$	Gate-Source Charge	--	6.2	--		
$Q_{gd}$	Gate-Drain (. Miller. ) Charge	--	23.3	--		

### Source-Drain Diode Ratings and Characteristics

Symbol	Characteristic	Min.	Typ.	Max.	Units	Test Condition
$I_S$	Continuous Source Current	--	--	28	A	Integral reverse pn-diode in the MOSFET
$I_{SM}$	Pulsed-Source Current (1)	--	--	98		
$V_{SD}$	Diode Forward Voltage (4)	--	--	1.5	V	$T_J=25^\circ\text{C}, I_S=28A, V_{GS}=0V$
$t_{rr}$	Reverse Recovery Time	--	132	--	ns	$T_J=25^\circ\text{C}, I_F=28A$
$Q_{rr}$	Reverse Recovery Charge	--	0.63	--	$\mu\text{C}$	$di_F/dt=100A/\mu\text{s}$ (4)

#### Notes;

- (1) Repetitive Rating: Pulse Width Limited by Maximum Junction Temperature
- (2)  $L=1\text{mH}, I_{AS}=28A, V_{DD}=25V, R_G=27\Omega,$  Starting  $T_J=25^\circ\text{C}$
- (3)  $I_{SD} \leq 28A, di/dt \leq 400A/\mu\text{s}, V_{DD} \leq BV_{DSS},$  Starting  $T_J=25^\circ\text{C}$
- (4) Pulse Test: Pulse Width = 250 $\mu\text{s}$ , Duty Cycle  $\leq 2\%$
- (5) Essentially Independent of Operating Temperature

**Fig 1. Output Characteristics**

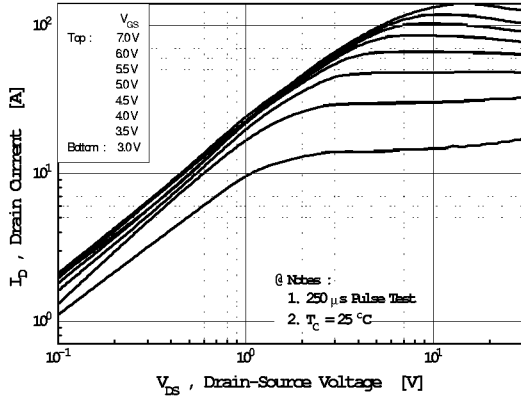

**Fig 2. Transfer Characteristics**

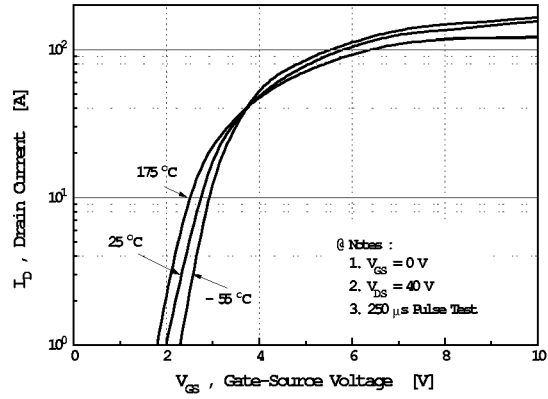

**Fig 3. On-Resistance vs. Drain Current**

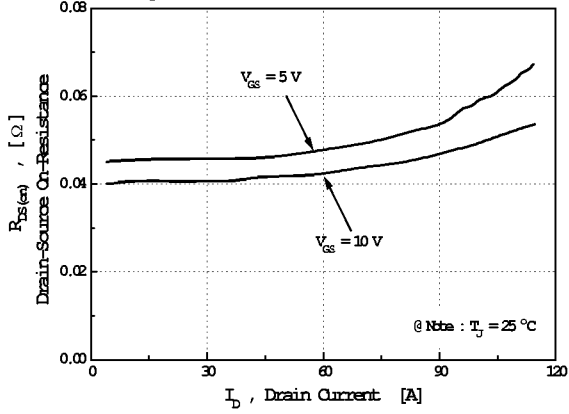

**Fig 4. Source-Drain Diode Forward Voltage**

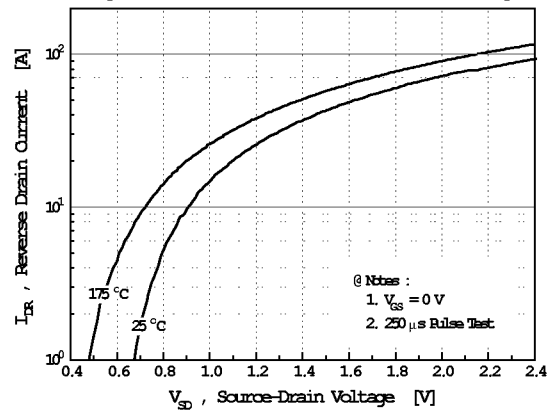

**Fig 5. Capacitance vs. Drain-Source Voltage**

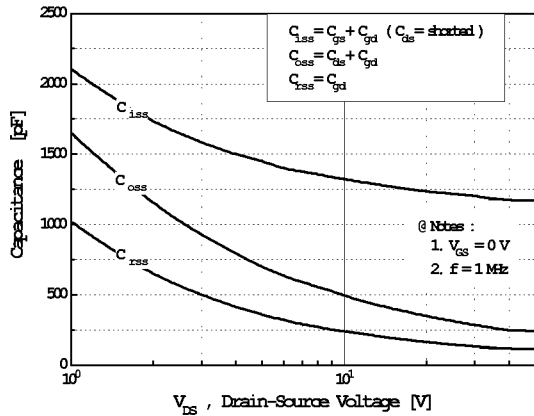

**Fig 6. Gate Charge vs. Gate-Source Voltage**

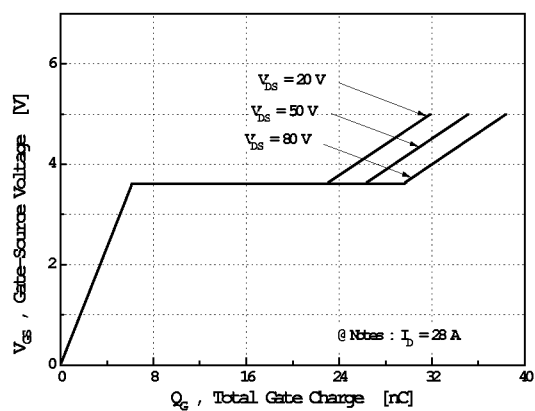

Fig 7. Breakdown Voltage vs. Temperature

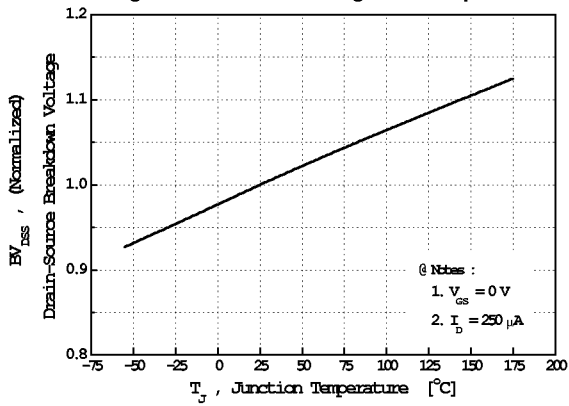

Fig 8. On-Resistance vs. Temperature

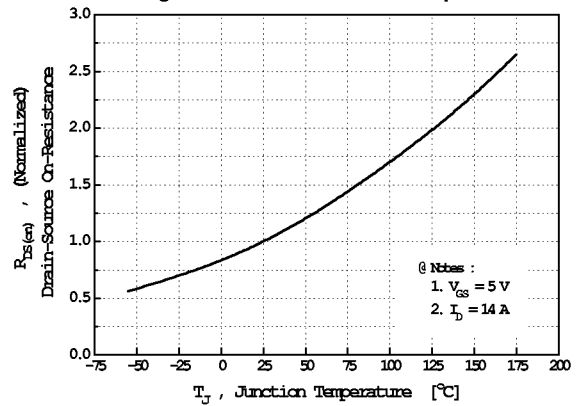

Fig 9. Max. Safe Operating Area

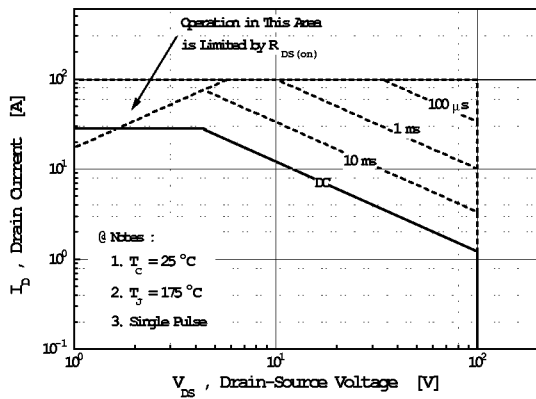

Fig 10. Max. Drain Current vs. Case Temperature

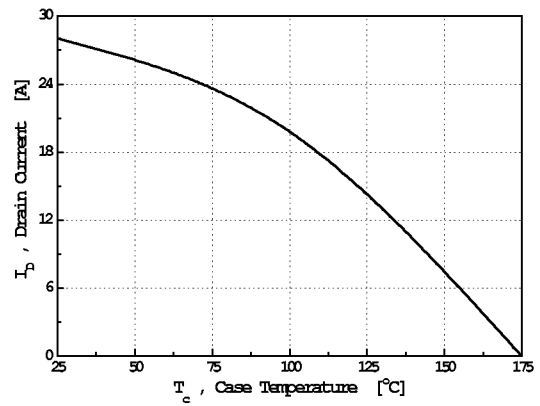
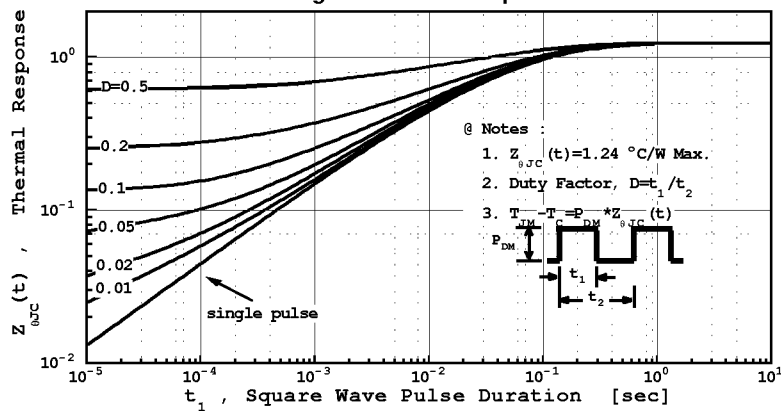
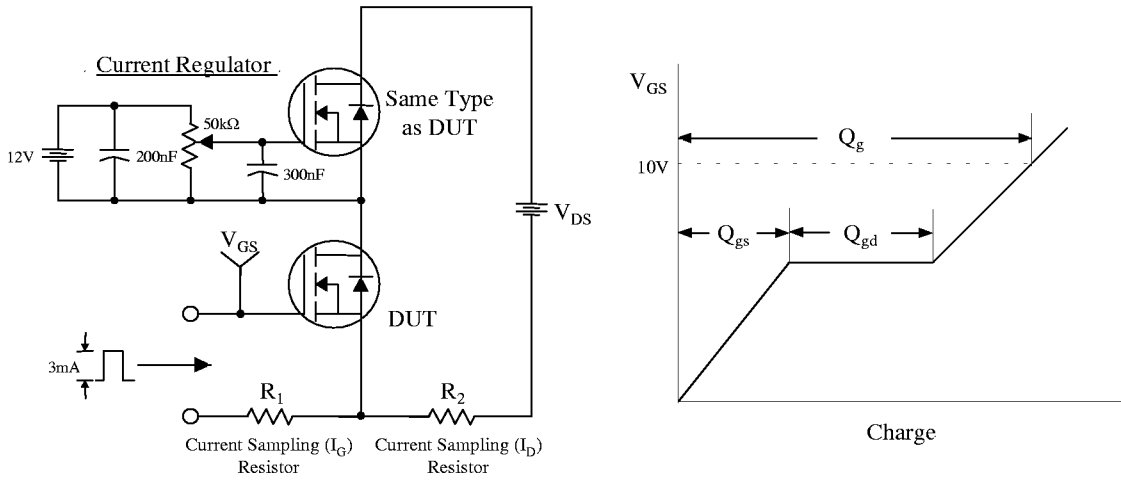

Fig 11. Thermal Response



**Fig 12. Gate Charge Test Circuit & Waveform**



**Fig 13. Resistive Switching Test Circuit & Waveforms**

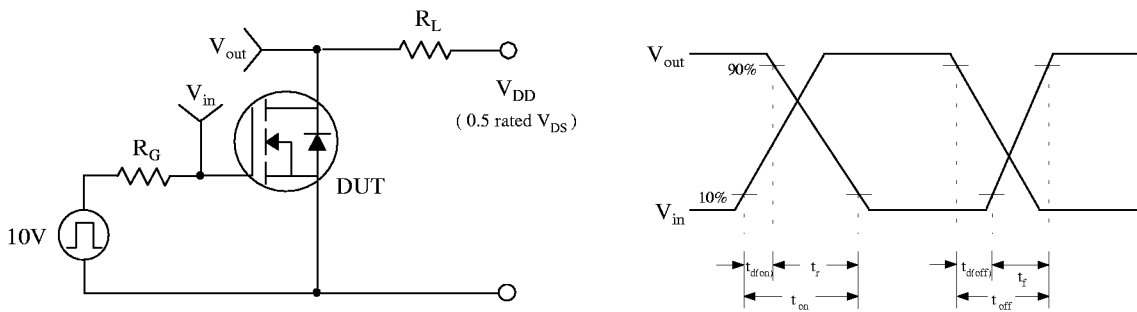

**Fig 14. Unclamped Inductive Switching Test Circuit & Waveforms**

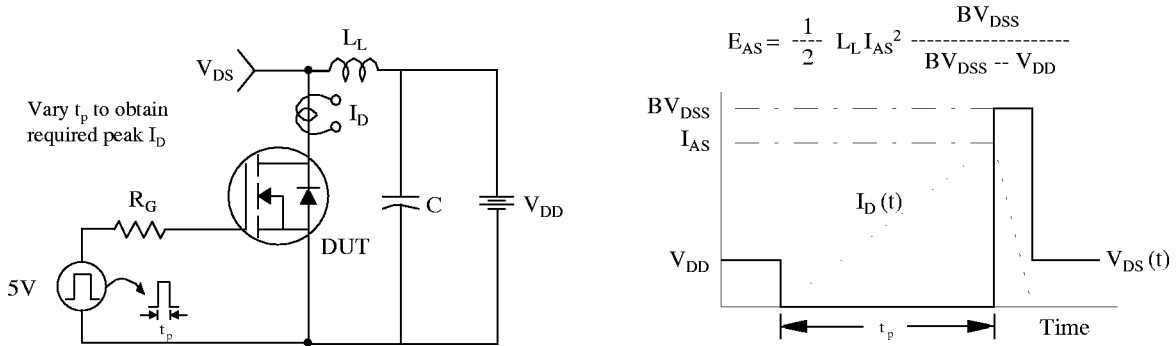
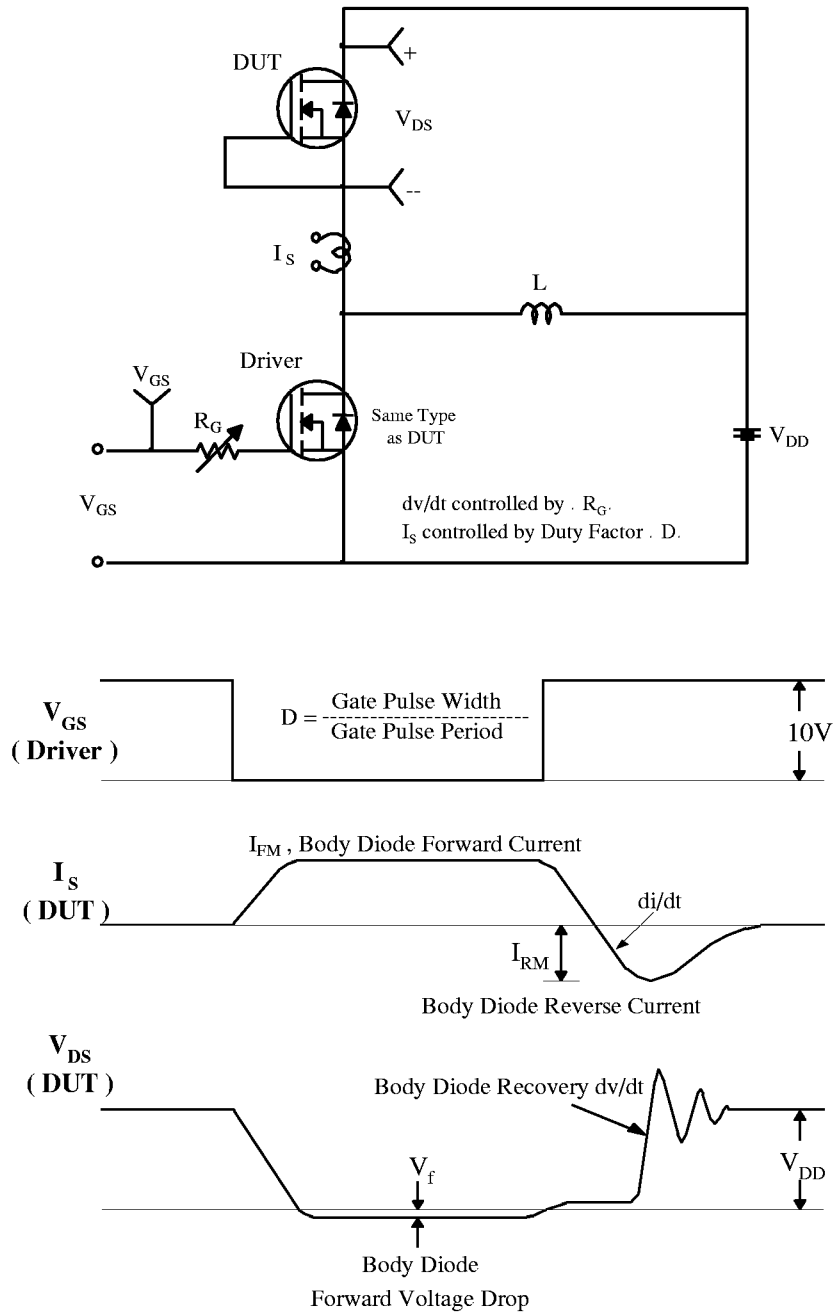

Fig 15. Peak Diode Recovery dv/dt Test Circuit & Waveforms



## TRADEMARKS

The following are registered and unregistered trademarks Fairchild Semiconductor owns or is authorized to use and is not intended to be an exhaustive list of all such trademarks.

ACEx™	ISOPLANAR™
CoolFET™	MICROWIRE™
CROSSVOLT™	POP™
E <sup>2</sup> CMOS™	PowerTrench™
FACT™	QS™
FACT Quiet Series™	Quiet Series™
FAST®	SuperSOT™-3
FASTr™	SuperSOT™-6
GTO™	SuperSOT™-8
HiSeC™	TinyLogic™

## DISCLAIMER

FAIRCHILD SEMICONDUCTOR RESERVES THE RIGHT TO MAKE CHANGES WITHOUT FURTHER NOTICE TO ANY PRODUCTS HEREIN TO IMPROVE RELIABILITY, FUNCTION OR DESIGN. FAIRCHILD DOES NOT ASSUME ANY LIABILITY ARISING OUT OF THE APPLICATION OR USE OF ANY PRODUCT OR CIRCUIT DESCRIBED HEREIN; NEITHER DOES IT CONVEY ANY LICENSE UNDER ITS PATENT RIGHTS, NOR THE RIGHTS OF OTHERS.

## LIFE SUPPORT POLICY

FAIRCHILD'S PRODUCTS ARE NOT AUTHORIZED FOR USE AS CRITICAL COMPONENTS IN LIFE SUPPORT DEVICES OR SYSTEMS WITHOUT THE EXPRESS WRITTEN APPROVAL OF FAIRCHILD SEMICONDUCTOR CORPORATION. As used herein:

1. Life support devices or systems are devices or systems which, (a) are intended for surgical implant into the body, or (b) support or sustain life, or (c) whose failure to perform when properly used in accordance with instructions for use provided in the labeling, can be reasonably expected to result in significant injury to the user.
2. A critical component is any component of a life support device or system whose failure to perform can be reasonably expected to cause the failure of the life support device or system, or to affect its safety or effectiveness.

## PRODUCT STATUS DEFINITIONS

### Definition of Terms

Datasheet Identification	Product Status	Definition
Advance Information	Formative or In Design	This datasheet contains the design specifications for product development. Specifications may change in any manner without notice.
Preliminary	First Production	This datasheet contains preliminary data, and supplementary data will be published at a later date. Fairchild Semiconductor reserves the right to make changes at any time without notice in order to improve design.
No Identification Needed	Full Production	This datasheet contains final specifications. Fairchild Semiconductor reserves the right to make changes at any time without notice in order to improve design.
Obsolete	Not In Production	This datasheet contains specifications on a product that has been discontinued by Fairchild semiconductor. The datasheet is printed for reference information only.