

Power Distribution Controllers

The HIP1015 and HIP1016 are hot swap power controllers. The HIP1015 is targeted for a +12V bus whereas the HIP1016 is targeted for +5V applications. Each has an undervoltage (UV) monitoring and reporting with a threshold level ~17% lower than the nominal +12V and +5V.

The HIP1015 has an integrated charge pump allowing control of up to a +12V bus using an external N-channel MOSFET. The HIP1016 can also be used to control much higher positive or negative voltages in a low side controller configuration. Both the HIP1015 and HIP1016 feature programmable Overcurrent (OC) detection, current limiting regulation with time delay to latch off and soft start.

Ordering Information

PART NUMBER	TEMP. RANGE (°C)	PACKAGE	PKG. NO.
HIP1015CB	0 to 85	8 Lead SOIC	M8.15
HIP1015CB-T	0 to 85	8 Lead SOIC Tape and Reel	M8.15
HIP1016CB	0 to 85	8 Lead SOIC	M8.15
HIP1016CB-T	0 to 85	8 Lead SOIC Tape and Reel	M8.15

Features

- HOT SWAP Single Power Distribution Control (HIP1015 for 12V, HIP1016 for 5V and Low Side Switch)
- Undervoltage Monitoring and Notification
- Overcurrent Fault Isolation
- Programmable Current Regulation Level
- Programmable Current Limit Time to Latch-Off
- Rail to Rail Common Mode Input Voltage Range (HIP1015)
- Internal Charge Pump Allows the use of N-channel MOSFET (HIP1015)
- Undervoltage and Overcurrent Latch Indicators
- Adjustable Turn-On Ramp
- Protection During Turn On
- Two Levels of Overcurrent Detection Provide Fast Response to Varying Fault Conditions
- Less Than 1µs Response Time to Dead Short

Applications

- Power Distribution Control
- Hot Plug Components and Circuitry
- High Side Low Voltage (< +15V) Switching
- Low Side High Voltage (> +15V, Negative V) Switch

Pinout

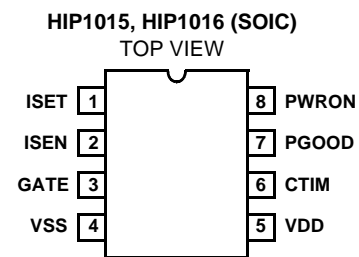

Application One - High Side Controller

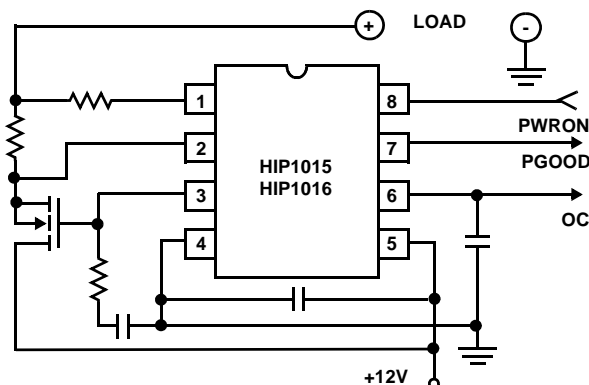

Application Two - Low Side Controller

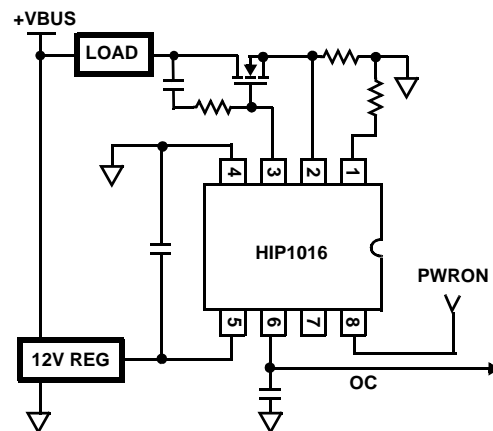

Simplified Block Diagram

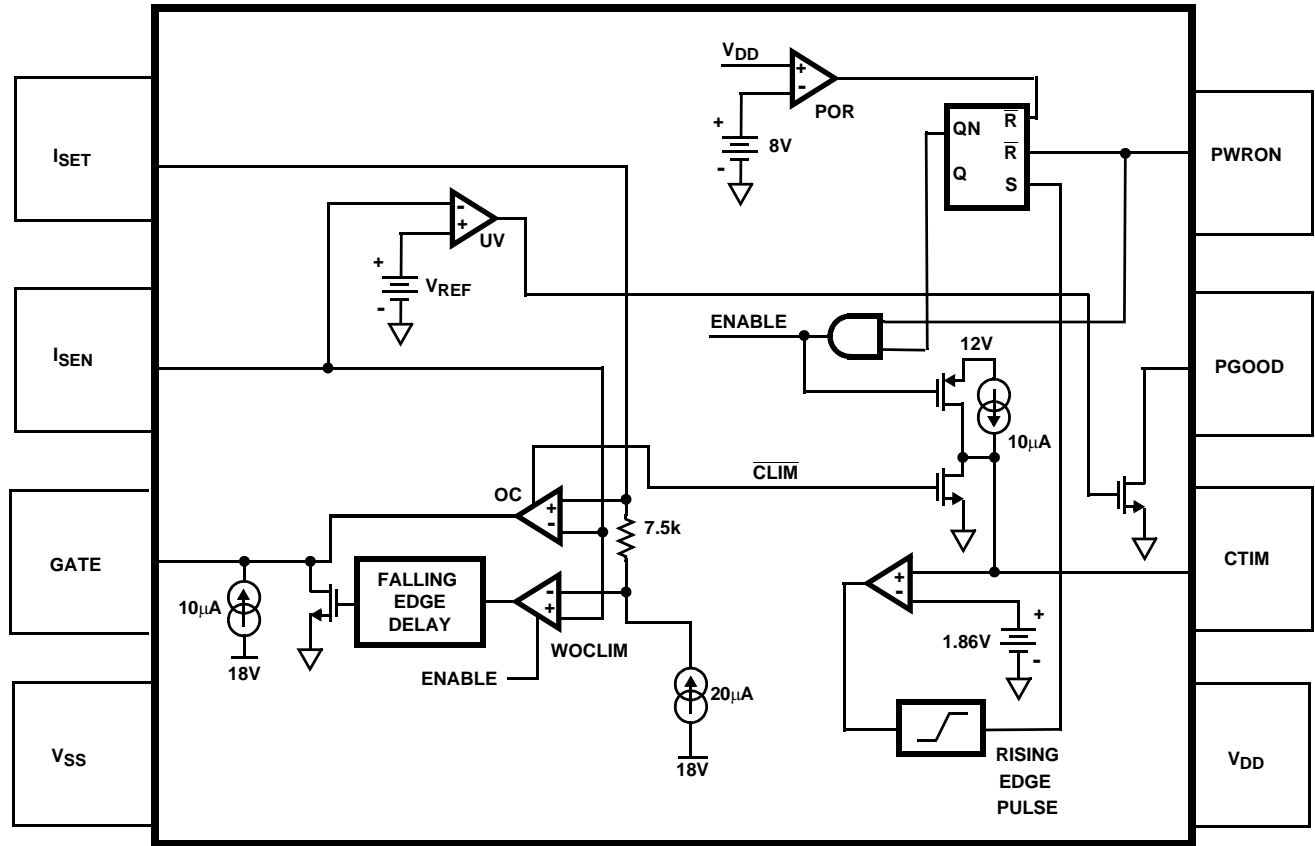

Pin Descriptions

PIN #	SYMBOL	FUNCTION	DESCRIPTION
1	ISET	Current Set	Connect to the low side of the current sense resistor through the current limiting set resistor. This pin functions as the current limit programming pin.
2	ISEN	Current Sense	Connect to the more positive end of sense resistor to measure the voltage drop across this resistor
3	GATE	External FET Gate Drive Pin	Connect to the gate of the external N-Channel MOSFET. A capacitor from this node to ground sets the turn-on ramp. At turn-on this capacitor will be charged to $V_{DD} + 5V$ (HIP1015) and to V_{DD} (HIP1016) by a $10\mu A$ current source.
4	VSS	Chip Return	
5	V_{DD}	Chip Supply	12V chip supply. This can be either connected directly to the +12V rail supplying the switched load voltage or to a dedicated $V_{SS} + 12V$ supply.
6	CTIM	Current Limit Timing Capacitor	Connect a capacitor from this pin to ground. This capacitor determines the time delay between an overcurrent event and chip output shutdown (current limit time-out). The duration of current limit time-out (in seconds) = $93k\Omega \times C_{TIM}$ (Farads).
7	PGOOD	Power Good Indicator	Indicates that the voltage on ISEN pin is within specification. PGOOD is driven by an open drain N-Channel MOSFET and is pulled low when the output is not within specification.
8	PWRON	Power ON	PWRON is used to control and reset the chip. The chip is enabled when PWRON pin is driven high or is open. After a current limit time out, the chip is reset by a low level signal applied to this pin. This input has $20\mu A$ pull up capability

HIP1015, HIP1016

Absolute Maximum Ratings $T_A = 25^{\circ}\text{C}$

V_{DD}	-0.3V to +16V
GATE	-0.3V to $V_{DD}+8\text{V}$
ISEN, PGOOD, PWRON, CTIM, ISET	-0.3V to $V_{DD} + 0.3\text{V}$
ESD Classification5kV

Operating Conditions

V_{DD} Supply Voltage Range	+12v \pm 15%
Temperature Range (T_A)	0°C to 85°C

CAUTION: Stresses above those listed in "Absolute Maximum Ratings" may cause permanent damage to the device. This is a stress only rating and operation of the device at these or any other conditions above those indicated in the operational sections of this specification is not implied.

NOTES:

- θ_{JA} is measured with the component mounted on a high effective thermal conductivity test board in free air. (See Tech Brief, #TB379.1 for details.)
- All voltages are relative to GND, unless otherwise specified.

Thermal Information

Thermal Resistance (Typical, Note 1)	θ_{JA} ($^{\circ}\text{C}/\text{W}$)
SOIC Package	98
Maximum Junction Temperature (Plastic Package)	150°C
Maximum Storage Temperature Range	-65°C to 150°C
Maximum Lead Temperature (Soldering 10s)	300°C (SOIC - Lead Tips Only)

Electrical Specifications $V_{DD} = 12\text{V}$, $T_A = T_J = 0^{\circ}\text{C}$ to 85°C , Unless Otherwise Specified

PARAMETER	SYMBOL	TEST CONDITIONS	MIN	TYP	MAX	UNITS
ISET Current Source	I_{SET}		18.5	20	21.5	μA
Current Limit Amp Offset Voltage		$V_{ISET} - V_{ISEN}$	-6	0	6	mV
Current Limit Time-Out Threshold Voltage	C_{TIM_Vth}	CTIM Voltage	1.3	1.8	2.3	V
GATE Response Time To Severe Overcurrent	pd_woc_amp	V_{GATE} to 10.8V	-	100	-	ns
GATE Response Time to Overcurrent	pd_oc_amp	V_{GATE} to 10.8V		600		ns
GATE Turn-On Current	I_{GATE}	V_{GATE} to = 6V	8.4	10	11.6	μA
GATE Pull down Current	OC_GATE_I_4V	Overcurrent	45	75		mA
GATE Pull down Current	WOC_GATE_I_4V	Severe Overcurrent	0.5	0.8	1.5	A
HIP1015 Undervoltage Threshold	12V $_{UV_VTH}$		9.2	9.6	10	V
HIP1015 Undervoltage Disabled	12V $_{UV_VTH_dis}$		$V_{DD}+1.9\text{V}$	$V_{DD}+2.5\text{V}$		V
HIP1015 GATE High Voltage	12VG	GATE Voltage	$V_{DD}+4.5\text{V}$	$V_{DD}+5\text{V}$	-	V
HIP1016 Undervoltage Threshold	5V $_{UV_VTH}$		4.0	4.35	4.5	V
HIP1016 Undervoltage Disabled	5V $_{UV_VTH_dis}$		$V_{DD}-3\text{V}$	$V_{DD}-2.5\text{V}$		V
HIP1016 GATE High Voltage	5VG	GATE Voltage	$V_{DD}-1.5\text{V}$	V_{DD}	-	V
V_{DD} Supply Current	I_{VDD}		-	3	5	mA
V_{DD} POR Rising Threshold	$V_{DD_POR_L2H}$	VDD Low to High	7.8	8.4	9	V
V_{DD} POR Falling Threshold	$V_{DD_POR_H2L}$	VDD High to Low	7.5	8.1	8.7	V
V_{DD} POR Threshold Hysteresis	$V_{DD_POR_HYS}$	$V_{DD_POR_L2H} - V_{DD_POR_H2L}$	0.1	0.3	0.6	V
PWRON Pull-up Voltage	PWRN_V	PWRON Pin Open	2.7	3.2	-	V
PWRON Rising Threshold	PWR_Vth		1.4	1.7	2.0	V
PWRON Hysteresis	PWR_hys		130	170	250	mV
PWRON Pull-Up Current	PWRN_I		9	17	25	μA
C_{TIM} Charging Current	C_{TIM_ichg0}	$V_{CTIM} = 0\text{V}$	16	20	23	μA
C_{TIM} Fault pull-up Current			16	20	23	mA
HIP1015 ISEN Current	ISEN_5V_I		41	72	88	μA
HIP1016 ISEN Current	ISEN_5V_I		100	145	170	μA

HIP1015, HIP1016 Description and Operation

The HIP1015 and HIP1016 are single power supply distribution controllers for generic hot swap applications. The HIP1015 is targeted for +12V switching applications whereas the HIP1016 is targeted for +5V applications as each has an undervoltage (UV) threshold level ~17% lower than the nominal +12V and +5V, respectively.

The HIP1015 and HIP1016 features include a highly accurate programmable Overcurrent (OC) detecting comparator, programmable current limiting regulation with programmable time delay to latch off and programmable soft start turn-on ramp all set with a minimum of external passive components. The HIP1015 and HIP1016 also include severe overcurrent protection that immediately shuts down the MOSFET switch should the load current cause the OC voltage threshold to exceed the programmed OC level by 150mV. Additionally the HIP1015 and HIP1016 have an UV indicator and an OC latch indicator.

Upon initial power up, the HIP1015 or HIP1016 can either isolate the voltage supply from the load by holding the external N-Channel MOSFET switch off or apply the supply rail voltage directly to the load for true hot swap capability. In either case the HIP1015 and HIP1016 turns on in a soft start mode protecting the supply rail from sudden in-rush current. The PWRON pin must be pulled low for the device to isolate the power supply from the load by holding the external N-channel MOSFET off, otherwise with the PWRON pin held high or floating the HIP1015 and HIP1016 will be in true hot swap mode.

At turn-on, the gate capacitor of the external N-Channel MOSFET is charged with a 10µA current source resulting in a programmable ramp (soft start turn-on). The internal HIP1015 charge pump supplies the gate drive for the 12V supply switch driving that gate to $V_{DD} + 5V$. The HIP1016 gate drive is limited to the chip bias voltage.

Load current passes through the external current sense resistor. When the voltage across the sense resistor exceeds the user programmed Overcurrent voltage threshold value, (See Table 1 for R_{ISET} programming resistor value and resulting nominal overcurrent threshold voltage, V_{OC}) the controller enters current regulation. At this time, the time-out capacitor, on C_{TIM} pin starts charging with a 20mA current source and the controller enters the current limit time to latch-off period. The length of the current limit time to latch-off period is set by the single external capacitor (See Table 2 for C_{TIM} capacitor value and resulting nominal current limited time out to latch-off period.) placed from the C_{TIM} pin (pin 6) to ground. The programmed current level is held until either the OC event passes or the time out period expires. If the former is the case then the N-Channel MOSFET is fully enhanced and the C_{TIM} capacitor is discharged. Once C_{TIM} charges to 1.87V, signaling that the time out period has expired an internal latch is set whereby

the FET gate is quickly pulled to 0V turning off the N-Channel MOSFET switch, isolating the faulty load.

TABLE 1.

R_{ISET} RESISTOR	NOMINAL OC V_{TH}
10kΩ	200mV
4.99kΩ	100mV
2.5kΩ	50mV
750Ω	15mV

NOTE: Nominal $V_{th} = R_{ISET} \times 20\mu A$.

TABLE 2.

C_{TIM} CAPACITOR	NOMINAL CURRENT LIMITED PERIOD
0.022µF	2ms
0.047µF	4.4ms
0.1µF	9.3ms

NOTE: Nominal time-out period in seconds = $C_{TIM} \times 93k\Omega$.

The HIP1015 and HIP1016 respond to a severe overcurrent load (defined as a voltage across the sense resistor >150mV over the OC V_{th} set point) by immediately, driving the N-Channel MOSFET gate to 0V in less than 1µs. The gate voltage is then slowly ramped up turning on the N-Channel MOSFET to the programmed current limit level, this is the start of the time out period.

Upon an UV condition the PGOOD signal will pull low when tied high through a resistor to the logic supply. This pin is an UV fault indicator. For an OC latch off indication, monitor C_{TIM} , pin 6. This pin will rise rapidly from 1.9V to 12V once the time out period expires.

The HIP1015 and HIP1016 are reset after an OC latch-off condition by a low level on the PWRON pin and is turned on by the PWRON pin being driven high.

Application Considerations

During the **Time-Out Delay Period** with the HIP1015 and HIP1016 in current limit mode, the V_{GS} of the external N-Channel MOSFETs is reduced driving the N-Channel MOSFET switch into a high $r_{DS(ON)}$ state. Thus avoid extended time out periods as the external N-Channel MOSFETs may be damaged or destroyed due to excessive internal power dissipation. Refer to the MOSFET manufacturers data sheet for SOA information.

With the high levels of inrush current e.g., highly capacitive loads and motor start up currents, **choosing the current limiting level** is crucial to provide both protection and still allow for this inrush current without latching off. Consider this in addition to the time out delay when choosing MOSFETs for your design.

Physical layout of R_{SENSE} resistor is critical to avoid the possibility of false overcurrent occurrences. Ideally trace routing between the R_{SENSE} resistors and the HIP1015 and HIP1016 is direct and as short as possible with zero current in the sense lines. (See Figure 1.)

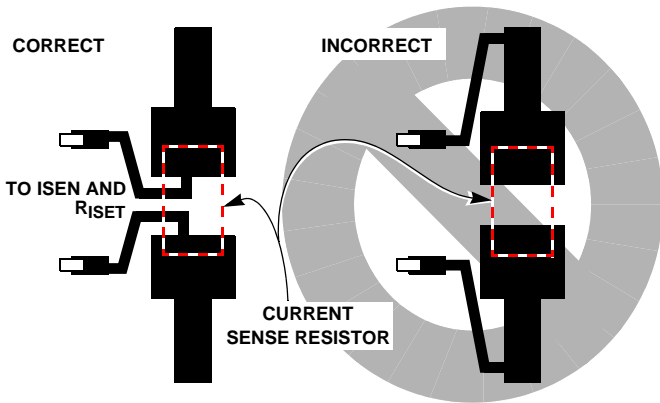

FIGURE 1. SENSE RESISTOR PCB LAYOUT

Using the HIP1016 as a -48V Low Side Hot Swap Power Controller

To supply the required V_{DD} , it is necessary to maintain the chip supply 12V above the -48V bus. This may be accomplished with a +12V Regulator between the voltage rail and pin 5 (VDD). By using a Regulator, the designer may ignore the bus voltage variations. However, a low-cost alternative is to use a Zener diode (See Figure 2 for typical 5A load control) this option is detailed below.

Note that in this configuration the PGOOD feature (pin 7) is not operational.

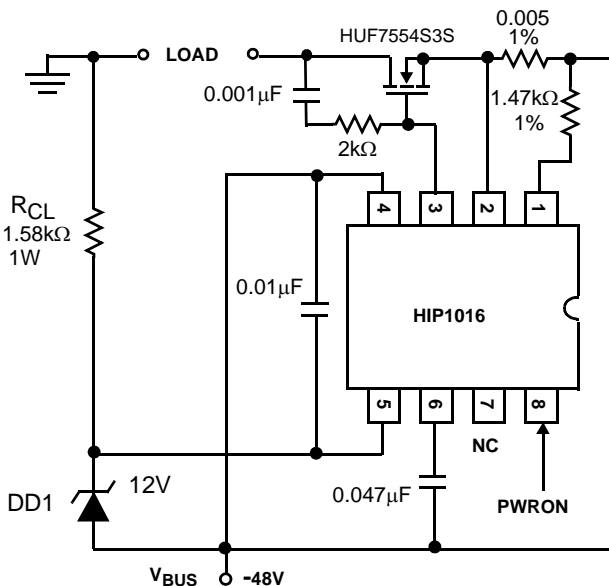

FIGURE 2.

Biasing the HIP1016

Table 3 gives typical component values for biasing the HIP1016 in a 48V application. The formulas and calculations deriving these values are also shown below.

TABLE 3. TYPICAL VALUES FOR A -48V HOT SWAP APPLICATION

SYMBOL	PARAMETER
R_{CL}	1.58k Ω , 1W
DD1	12V Zener Diode, 50mA Reverse Current

When using the HIP1016 to control -48V, a Zener diode may be used to provide the +12V bias to the chip. If a Zener is used then a current limit resistor should also be used. Several items must be taken into account when choosing values for the current limit resistor (R_{CL}) and Zener Diode (DD1):

- The variation of the V_{BUS} (in this case, -48V)
- The chip supply current needs for all functional conditions
- The power rating of R_{CL} .
- The current rating of DD1

Formulas

1. Sizing R_{CL} :

$$R_{CL} = (V_{BUS,MIN} - 12) / I_{CHIP}$$
2. Power Rating of R_{CL} :

$$P_{RCL} = I_C (V_{BUS,MAX} - 12)$$
3. DD1 Current Rating:

$$I_{DD1} = (V_{BUS,MAX} - 12) / R_{CL}$$

Example:

A typical -48V supply may vary from -36 to -72V. Therefore,
 $V_{BUS,MAX} = -72V$
 $V_{BUS,MIN} = -36V$

$I_{CHIP} = 15mA$ (max)

Sizing R_{CL} :

$$R_{CL} = (V_{BUS,MIN} - 12) / I_C$$

$$R_{CL} = (36 - 12) / 0.015$$
 $R_{CL} = 1.6k\Omega$ [Typical Value = 1.58k Ω]

Power Rating of R_{CL} :

$$P_{RCL} = I_C (V_{BUS,MAX} - 12)$$

$$P_{RCL} = (0.015)(72 - 12)$$
 $P_{RCL} = 0.9W$ [Typical Value = 1W]

DD1 Current Rating:

$$I_{DD1} = (V_{BUS,MAX} - 12) / R_{CL}$$

$$I_{DD1} = (72 - 12) / 1.58k\Omega$$
 $I_{DD1} = 38mA$ [Typical Value = 12V rating, 50mA reverse current]

Typical Performance Curves

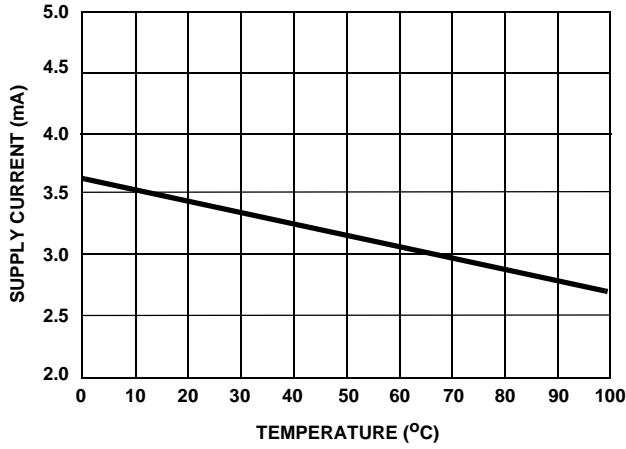

FIGURE 3. VDD BIAS CURRENT

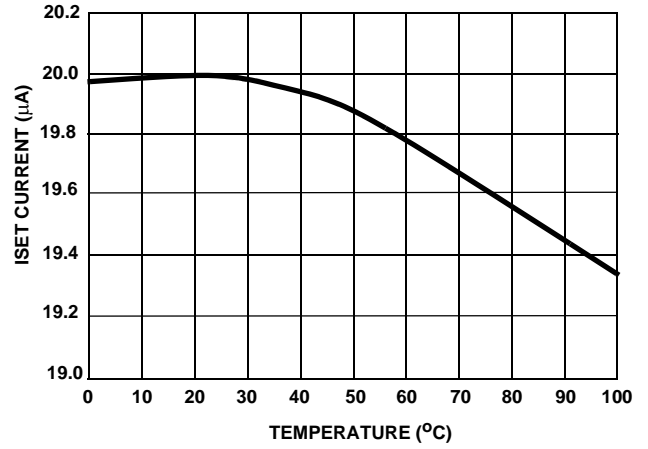

FIGURE 4. ISET SOURCE CURRENT

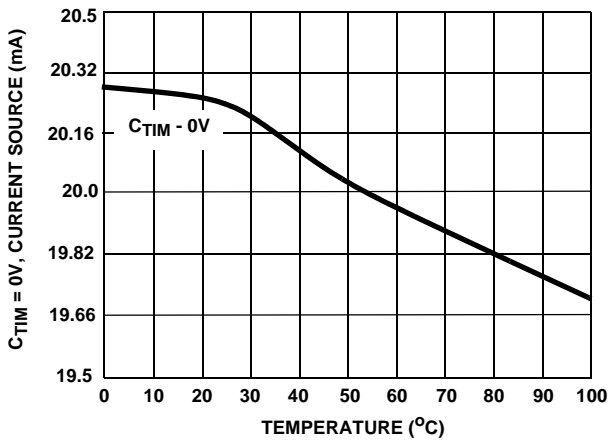

FIGURE 5. C_{TIM} CURRENT SOURCE

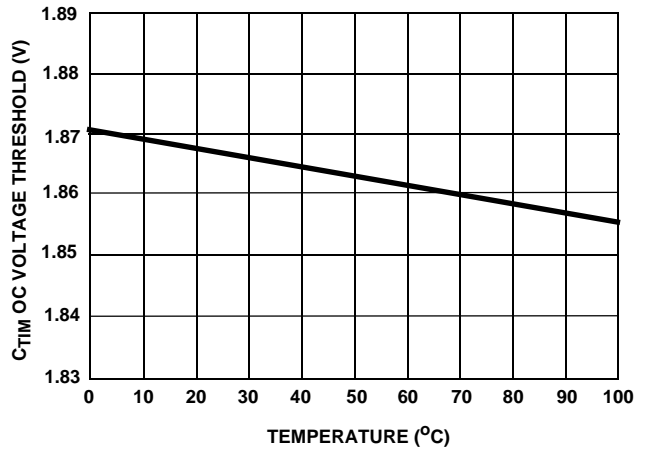

FIGURE 6. C_{TIM} OC VOLTAGE THRESHOLD

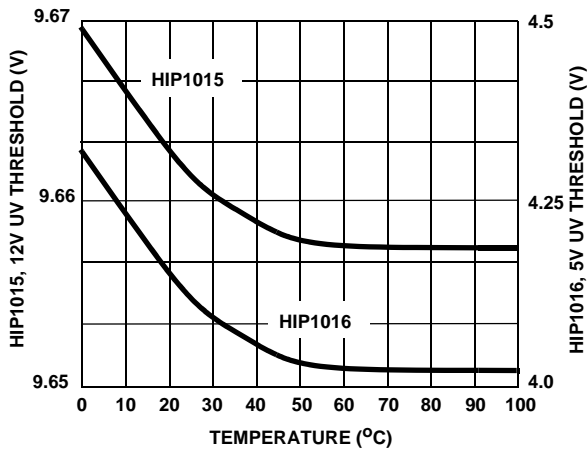

FIGURE 7. UV THRESHOLD

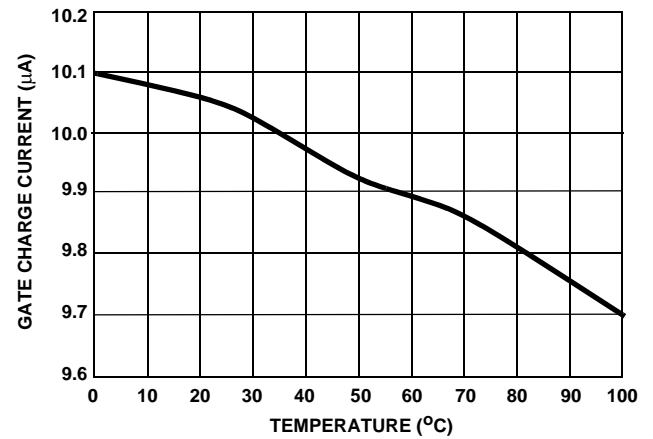

FIGURE 8. GATE CHARGE CURRENT

Typical Performance Curves (Continued)

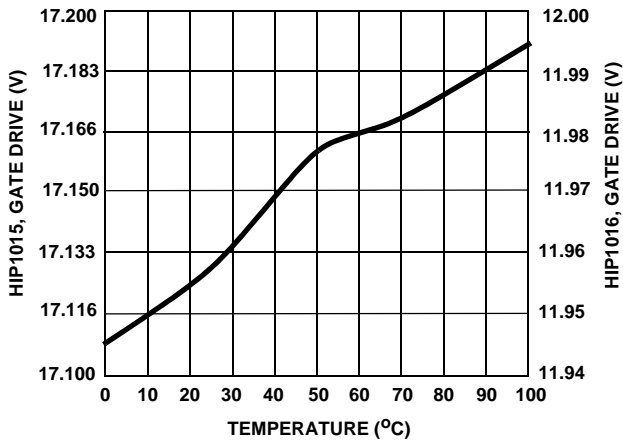

FIGURE 9. GATE DRIVE VOLTAGE, VDD = 12V

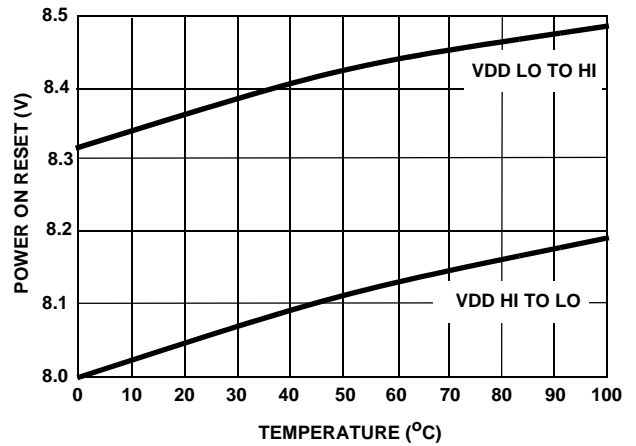

FIGURE 10. POWER ON RESET VOLTAGE THRESHOLD

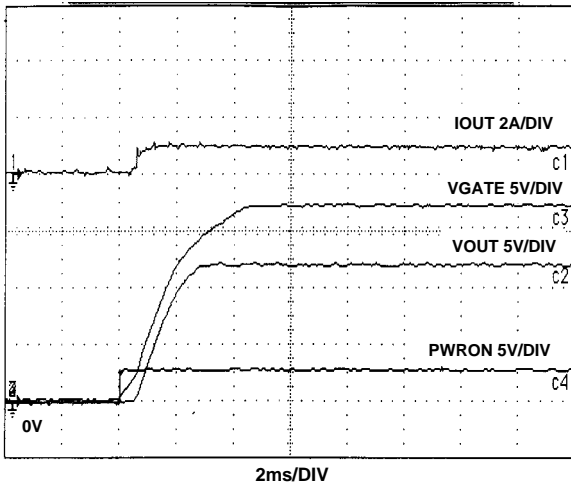

FIGURE 11. HIP1015 HIGH SIDE +12V TURN-ON

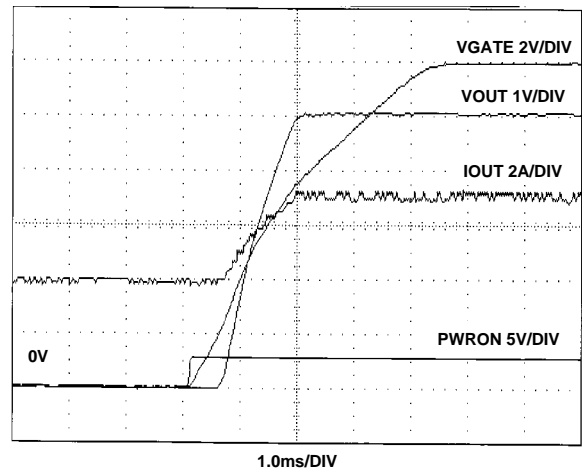

FIGURE 12. HIP1016 HIGH SIDE +5V TURN-ON

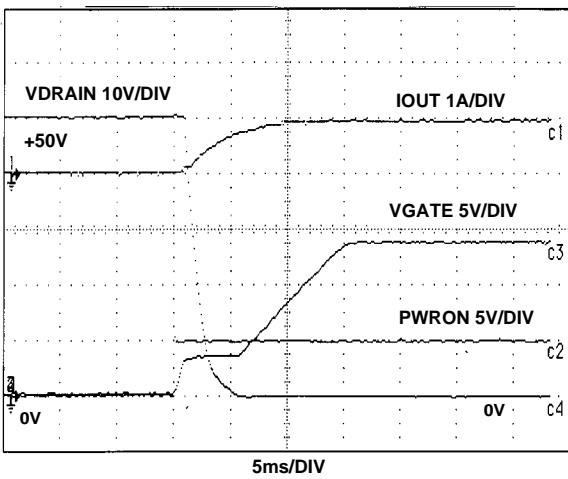

FIGURE 13. +50V LOW SIDE SWITCHING CGATE = 100pF

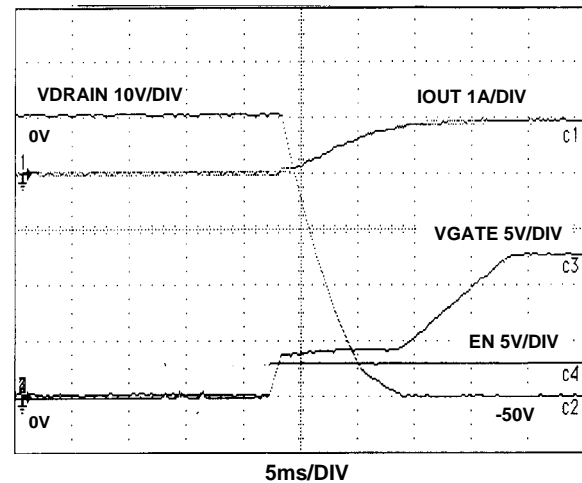

FIGURE 14. -50V LOW SIDE SWITCHING CGATE = 1000pF

Typical Performance Curves (Continued)

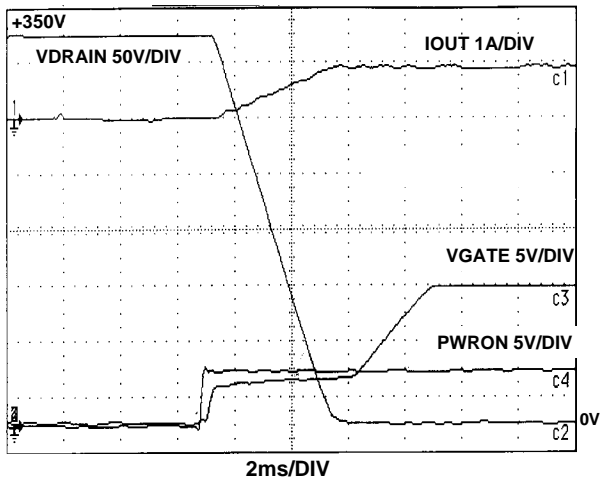

FIGURE 15. +350V LOW SIDE SWITCHING CGATE = 100pF

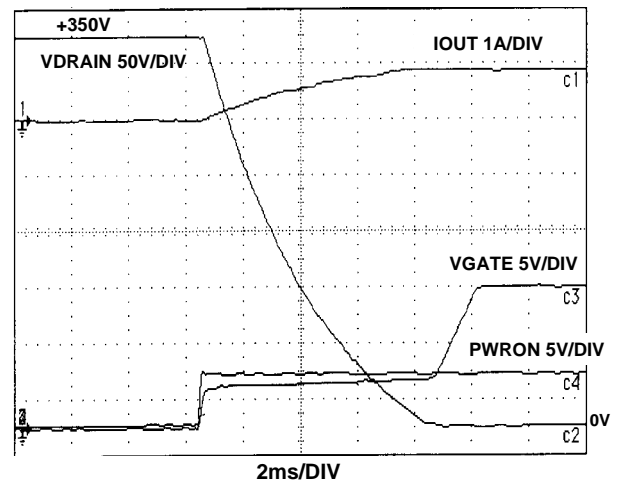
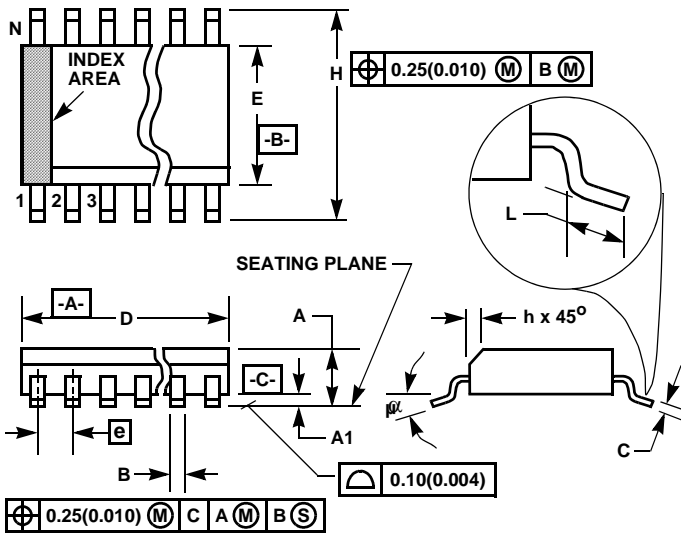

FIGURE 16. +350V LOW SIDE SWITCHING CGATE = 1000pF

Small Outline Plastic Packages (SOIC)



M8.15 (JEDEC MS-012-AA ISSUE C)
8 LEAD NARROW BODY SMALL OUTLINE PLASTIC PACKAGE

SYMBOL	INCHES		MILLIMETERS		NOTES
	MIN	MAX	MIN	MAX	
A	0.0532	0.0688	1.35	1.75	-
A1	0.0040	0.0098	0.10	0.25	-
B	0.013	0.020	0.33	0.51	9
C	0.0075	0.0098	0.19	0.25	-
D	0.1890	0.1968	4.80	5.00	3
E	0.1497	0.1574	3.80	4.00	4
e	0.050 BSC		1.27 BSC		-
H	0.2284	0.2440	5.80	6.20	-
h	0.0099	0.0196	0.25	0.50	5
L	0.016	0.050	0.40	1.27	6
N	8		8		7
α	0°	8°	0°	8°	-

NOTES:

1. Symbols are defined in the "MO Series Symbol List" in Section 2.2 of Publication Number 95.
2. Dimensioning and tolerancing per ANSI Y14.5M-1982.
3. Dimension "D" does not include mold flash, protrusions or gate burrs. Mold flash, protrusion and gate burrs shall not exceed 0.15mm (0.006 inch) per side.
4. Dimension "E" does not include interlead flash or protrusions. Interlead flash and protrusions shall not exceed 0.25mm (0.010 inch) per side.
5. The chamfer on the body is optional. If it is not present, a visual index feature must be located within the crosshatched area.
6. "L" is the length of terminal for soldering to a substrate.
7. "N" is the number of terminal positions.
8. Terminal numbers are shown for reference only.
9. The lead width "B", as measured 0.36mm (0.014 inch) or greater above the seating plane, shall not exceed a maximum value of 0.61mm (0.024 inch).
10. Controlling dimension: MILLIMETER. Converted inch dimensions are not necessarily exact.

Rev. 0 12/93

All Intersil U.S. products are manufactured, assembled and tested utilizing ISO9000 quality systems. Intersil Corporation's quality certifications can be viewed at www.intersil.com/design/quality

Intersil products are sold by description only. Intersil Corporation reserves the right to make changes in circuit design, software and/or specifications at any time without notice. Accordingly, the reader is cautioned to verify that data sheets are current before placing orders. Information furnished by Intersil is believed to be accurate and reliable. However, no responsibility is assumed by Intersil or its subsidiaries for its use; nor for any infringements of patents or other rights of third parties which may result from its use. No license is granted by implication or otherwise under any patent or patent rights of Intersil or its subsidiaries.

For information regarding Intersil Corporation and its products, see www.intersil.com