



NPN SILICON HIGH FREQUENCY TRANSISTOR

UPA802T

FEATURES

- **SMALL PACKAGE STYLE:**
2 NE681 Die in a 2 mm x 1.25 mm package
- **LOW NOISE FIGURE:**
NF = 1.4 dB TYP at 1 GHz
- **HIGH GAIN:**
 $IS_{21E}I^2 = 12$ dB TYP at 1 GHz
- **HIGH GAIN BANDWIDTH:** $f_T = 7$ GHz
- **LOW CURRENT OPERATION**

DESCRIPTION

NEC's UPA802T is two NPN high frequency silicon epitaxial transistors encapsulated in an ultra small 6 pin SMT package. Each transistor is independently mounted and easily configured for either dual transistor or cascode operation. The high f_T , low voltage bias and small size make this device suited for various hand-held wireless applications.

OUTLINE DIMENSIONS (Units in mm)

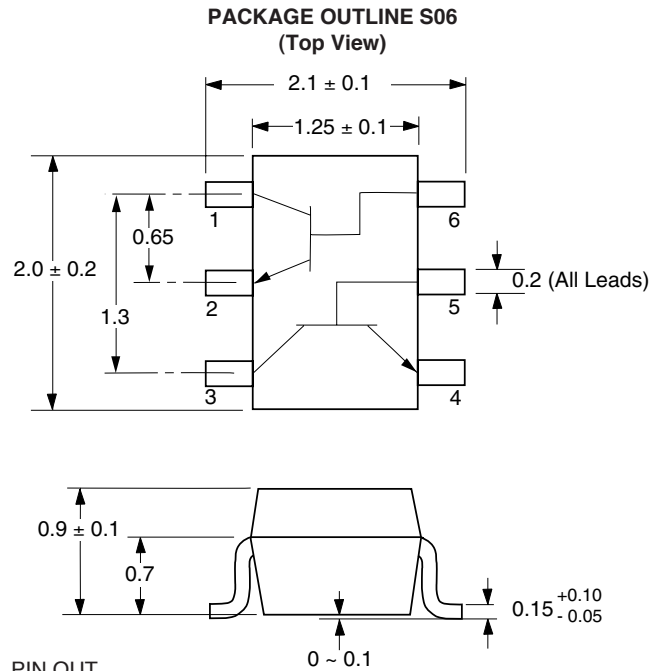

- PIN OUT**
1. Collector Transistor 1
 2. Emitter Transistor 1
 3. Collector Transistor 2
 4. Emitter Transistor 2
 5. Base Transistor 2
 6. Base Transistor 1

Note:
Pin 3 is identified with a circle on the bottom of the package.

ELECTRICAL CHARACTERISTICS ($T_A = 25^\circ\text{C}$)

PART NUMBER PACKAGE OUTLINE			UPA802T S06		
SYMBOLS	PARAMETERS AND CONDITIONS	UNITS	MIN	TYP	MAX
I_{CBO}	Collector Cutoff Current at $V_{CB} = 10$ V, $I_E = 0$	μA			0.8
I_{EBO}	Emitter Cutoff Current at $V_{EB} = 1$ V, $I_C = 0$	μA			0.8
h_{FE}^1	Forward Current Gain at $V_{CE} = 3$ V, $I_C = 7$ mA		70	100	240
f_T	Gain Bandwidth at $V_{CE} = 3$ V, $I_C = 7$ mA, $f = 1$ GHz	GHz	4.5	7.0	
C_{re}^2	Feedback Capacitance at $V_{CB} = 3$ V, $I_E = 0$, $f = 1$ MHz	pF			0.9
$IS_{21E}I^2$	Insertion Power Gain at $V_{CE} = 3$ V, $I_C = 7$ mA, $f = 1$ GHz	dB	10	12	
NF	Noise Figure at $V_{CE} = 3$ V, $I_C = 7$ mA, $f = 1$ GHz	dB		1.4	1.7
h_{FE1}/h_{FE2}	h_{FE} Ratio: $h_{FE1} =$ Smaller Value of Q_1 , or Q_2 $h_{FE2} =$ Larger Value of Q_1 or Q_2		0.85		

- Notes: 1. Pulsed measurement, pulse width ≤ 350 μs , duty cycle $\leq 2\%$.
2. The emitter terminal should be connected to the ground terminal of the 3 terminal capacitance bridge.
For Tape and Reel version use part number UPA802T-T1, 3K per reel.

ABSOLUTE MAXIMUM RATINGS¹ ($T_A = 25^\circ\text{C}$)

SYMBOLS	PARAMETERS	UNITS	RATINGS
V _{CB0}	Collector to Base Voltage	V	20
V _{CE0}	Collector to Emitter Voltage	V	10
V _{EB0}	Emitter to Base Voltage	V	1.5
I _C	Collector Current	mA	65
PT	Total Power Dissipation	1 Die	mW 110
		2 Die	mW 200
T _J	Junction Temperature	°C	150
T _{STG}	Storage Temperature	°C	-65 to +150

Note: 1. Operation in excess of any one of these parameters may result in permanent damage.

TOTAL POWER DISSIPATION vs. AMBIENT TEMPERATURE

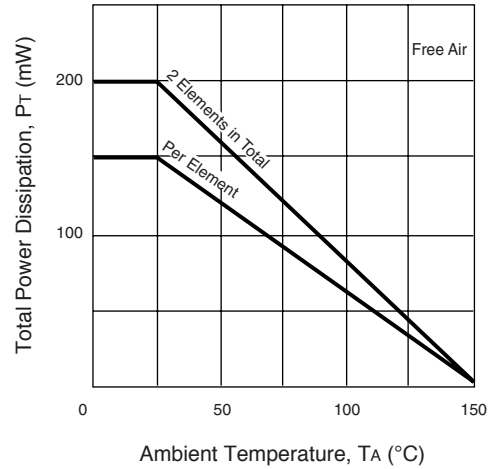

TYPICAL PERFORMANCE CURVES ($T_A = 25^\circ\text{C}$)

COLLECTOR CURRENT vs. COLLECTOR TO EMITTER VOLTAGE

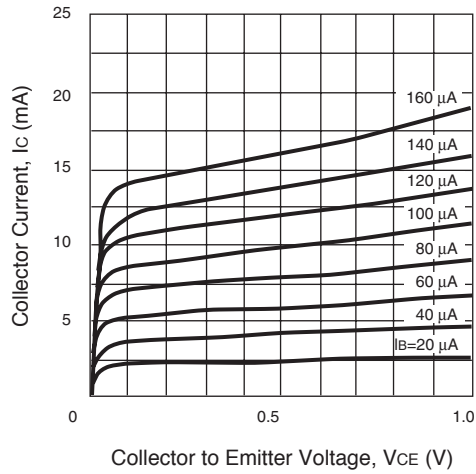

COLLECTOR CURRENT vs. BASE TO EMITTER VOLTAGE

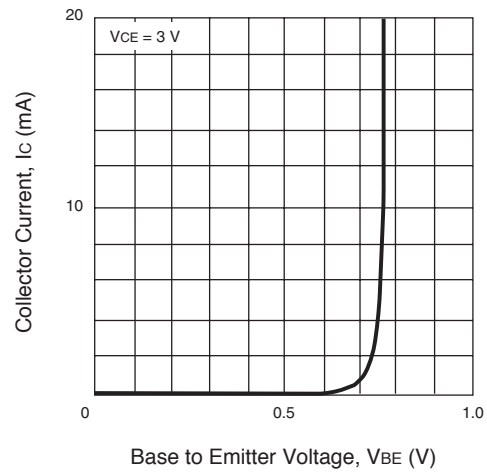

DC CURRENT GAIN vs. COLLECTOR CURRENT

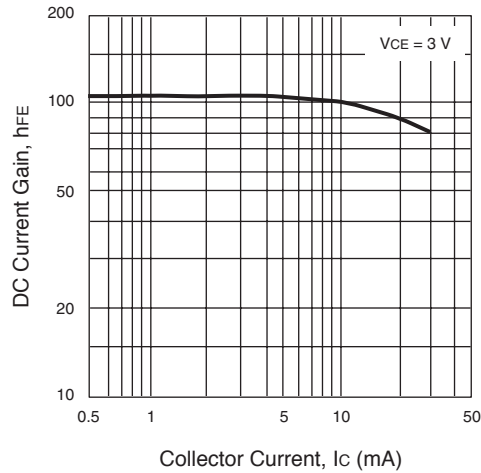

FEED BACK CAPACITANCE vs. COLLECTOR TO BASE VOLTAGE

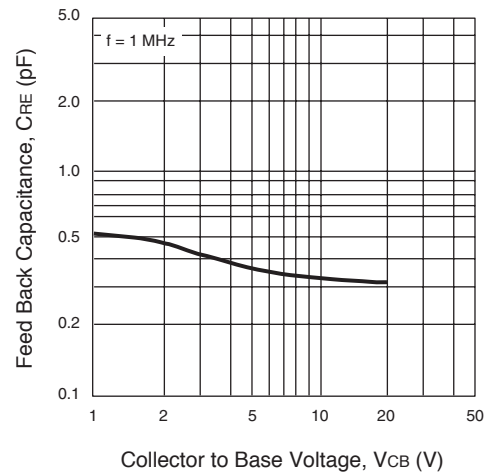

TYPICAL PERFORMANCE CURVES ($T_A = 25^\circ\text{C}$)

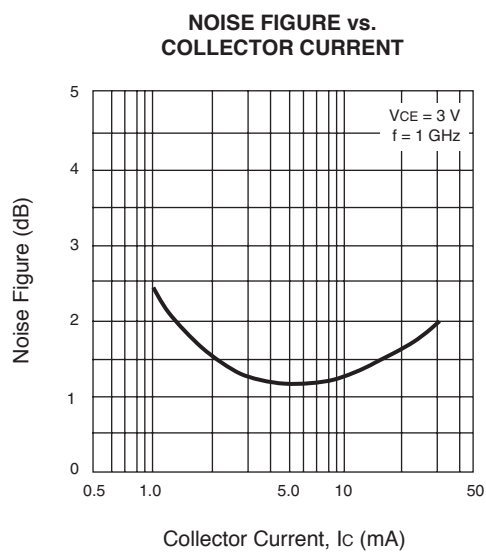
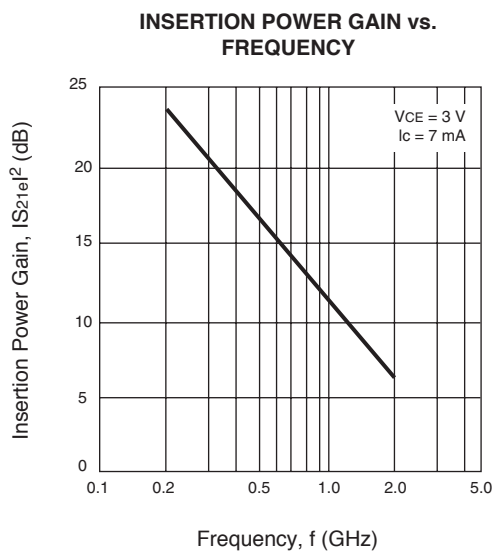
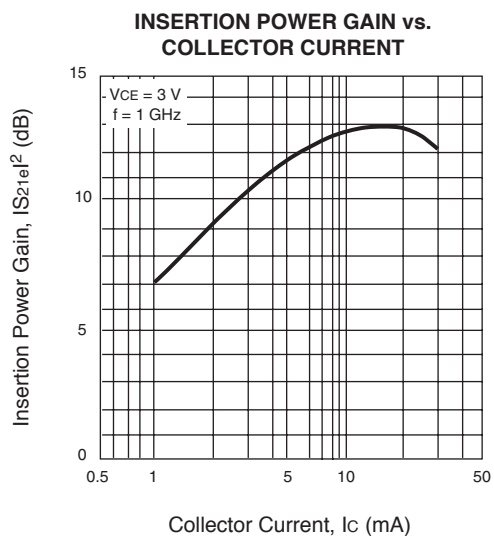
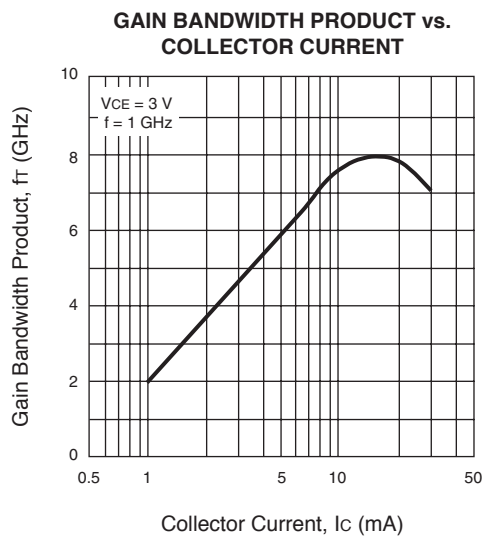

TYPICAL SCATTERING PARAMETERS (TA = 25°C)

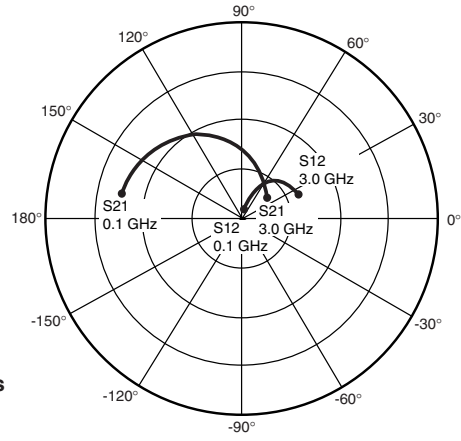
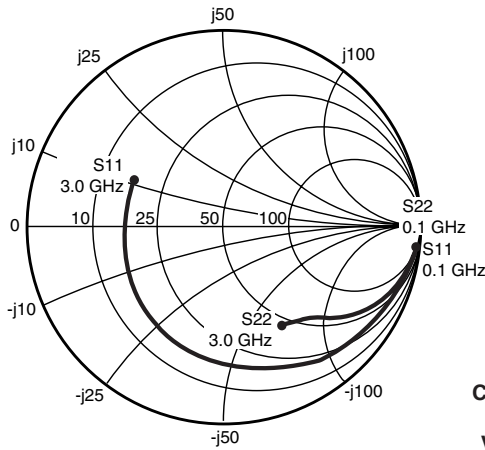

Coordinates in Ohms
 Frequency in GHz
 VCE = 1 V, IC = 1 mA
 Zo = 50 Ω

UPA802T(Q1)

VCE = 1 V, IC = 1 mA

FREQUENCY (GHz)	S11		S21		S12		S22		K	Gmag (dB)
	MAG	ANG	MAG	ANG	MAG	ANG	MAG	ANG		
0.10	0.958	-15.16	3.187	166.69	0.032	79.93	0.988	-6.58	0.09	19.96
0.20	0.928	-28.69	3.093	156.52	0.062	71.38	0.963	-12.80	0.13	16.97
0.40	0.848	-55.75	2.811	136.55	0.108	55.84	0.888	-22.64	0.24	14.15
0.60	0.760	-78.46	2.474	120.48	0.136	44.42	0.814	-29.45	0.35	12.60
0.80	0.687	-97.04	2.147	107.67	0.150	36.37	0.754	-34.20	0.47	11.54
1.00	0.633	-112.40	1.863	97.49	0.157	30.81	0.714	-37.74	0.58	10.75
1.20	0.596	-125.48	1.654	88.81	0.157	27.29	0.679	-40.65	0.71	10.23
1.40	0.569	-136.93	1.479	81.45	0.155	25.10	0.659	-43.13	0.84	9.79
1.60	0.551	-147.13	1.341	75.09	0.150	24.63	0.642	-45.30	0.98	9.51
1.80	0.540	-156.65	1.225	69.42	0.146	24.53	0.635	-47.38	1.11	7.24
2.00	0.531	-165.70	1.132	64.10	0.140	26.86	0.624	-49.27	1.27	5.96
2.20	0.526	-174.27	1.055	59.52	0.136	29.55	0.620	-51.13	1.40	5.14
2.40	0.520	177.45	0.992	55.07	0.133	34.37	0.610	-53.10	1.54	4.38
2.60	0.520	169.16	0.930	51.37	0.132	39.26	0.607	-54.72	1.64	3.77
2.80	0.517	161.23	0.880	47.57	0.135	45.21	0.602	-56.65	1.71	3.21
3.00	0.520	153.22	0.836	44.36	0.142	50.87	0.594	-58.18	1.74	2.70

Note:

1. Gain Calculation:

$$MAG = \frac{|S_{21}|}{|S_{12}|} \left(K \pm \sqrt{K^2 - 1} \right). \text{ When } K \leq 1, \text{ MAG is undefined and MSG values are used. } MSG = \frac{|S_{21}|}{|S_{12}|}, K = \frac{1 + |\Delta|^2 - |S_{11}|^2 - |S_{22}|^2}{2 |S_{12} S_{21}|}, \Delta = S_{11} S_{22} - S_{21} S_{12}$$

MAG = Maximum Available Gain

MSG = Maximum Stable Gain

TYPICAL SCATTERING PARAMETERS (T_A = 25°C)

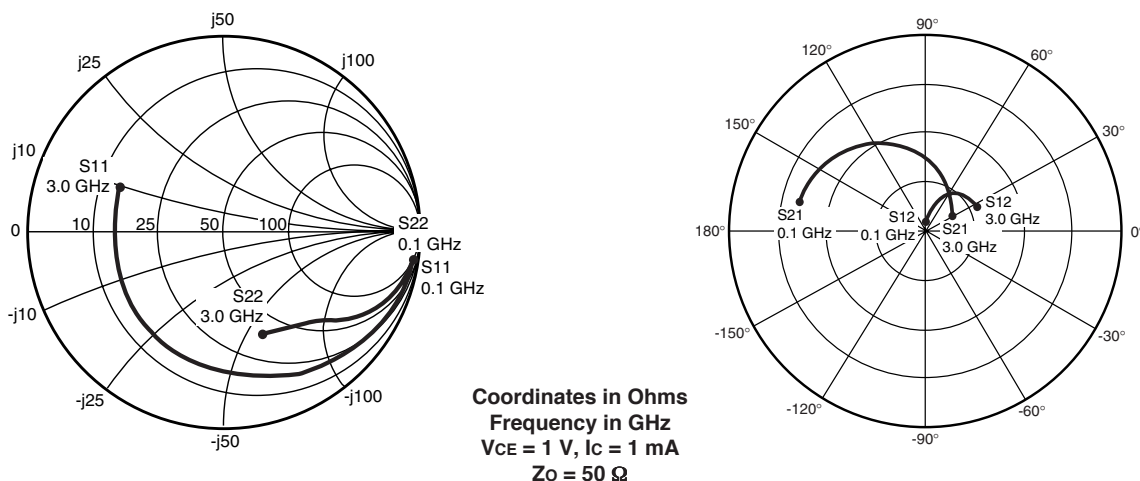

UPA802T(Q2)

V_{CE} = 1 V, I_c = 1 mA

FREQUENCY (GHz)	S ₁₁		S ₂₁		S ₁₂		S ₂₂		K	Gmag (dB)
	MAG	ANG	MAG	ANG	MAG	ANG	MAG	ANG		
0.10	0.957	-14.40	3.197	167.02	0.030	80.47	0.989	-6.14	0.09	20.25
0.20	0.931	-28.20	3.113	157.17	0.059	71.80	0.966	-12.02	0.13	17.25
0.40	0.856	-55.36	2.858	137.29	0.103	56.14	0.894	-21.53	0.23	14.41
0.60	0.770	-78.82	2.541	120.96	0.132	44.20	0.819	-28.30	0.34	12.86
0.80	0.697	-98.60	2.222	107.64	0.147	35.41	0.756	-33.20	0.46	11.80
1.00	0.646	-115.24	1.934	96.85	0.154	29.00	0.710	-37.02	0.57	11.00
1.20	0.611	-129.46	1.718	87.54	0.154	24.60	0.670	-40.30	0.70	10.47
1.40	0.590	-141.68	1.533	79.60	0.153	21.50	0.645	-43.31	0.82	10.02
1.60	0.579	-152.33	1.383	72.70	0.148	20.19	0.623	-46.01	0.97	9.72
1.80	0.575	-161.59	1.258	66.56	0.144	19.08	0.615	-49.02	1.08	7.65
2.00	0.574	-170.02	1.158	60.84	0.137	20.45	0.600	-51.86	1.25	6.29
2.20	0.576	-177.47	1.071	55.92	0.131	22.10	0.594	-54.76	1.38	5.42
2.40	0.576	175.74	1.002	51.22	0.126	26.20	0.580	-57.65	1.56	4.60
2.60	0.580	169.40	0.938	47.30	0.124	30.61	0.578	-60.58	1.67	4.00
2.80	0.579	163.57	0.884	43.32	0.124	36.59	0.572	-63.54	1.78	3.41
3.00	0.581	157.88	0.839	39.98	0.128	42.78	0.563	-66.31	1.84	2.87

Note:

1. Gain Calculation:

$$MAG = \frac{|S_{21}|}{|S_{12}|} \left(K \pm \sqrt{K^2 - 1} \right). \text{ When } K \leq 1, \text{ MAG is undefined and MSG values are used. } MSG = \frac{|S_{21}|}{|S_{12}|}, K = \frac{1 + |\Delta|^2 - |S_{11}|^2 - |S_{22}|^2}{2 |S_{12} S_{21}|}, \Delta = S_{11} S_{22} - S_{21} S_{12}$$

MAG = Maximum Available Gain

MSG = Maximum Stable Gain

TYPICAL SCATTERING PARAMETERS (T_A = 25°C)

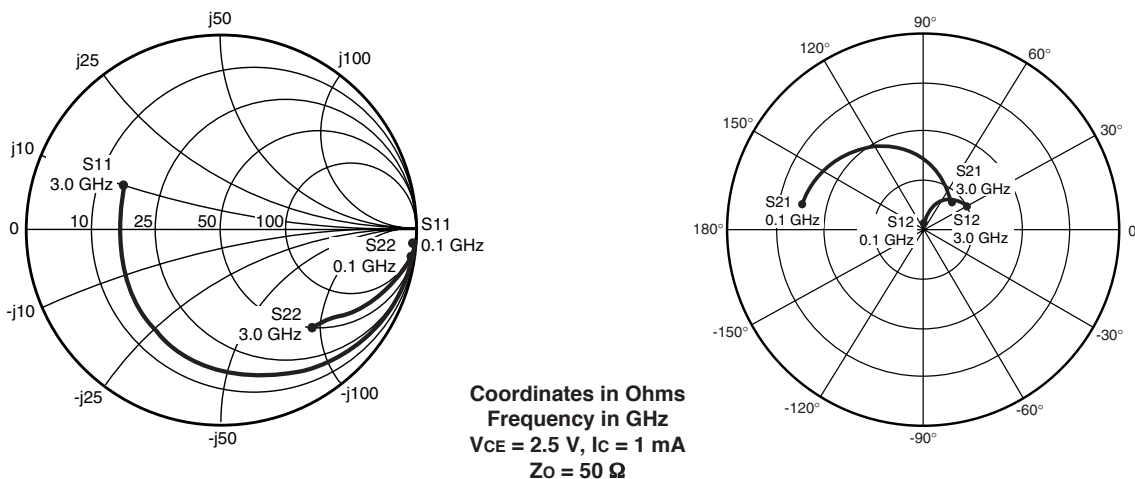

UPA802T(Q1)

V_{CE} = 2.5 V, I_C = 1 mA

FREQUENCY (GHz)	S ₁₁		S ₂₁		S ₁₂		S ₂₂		K	Gmag (dB)
	MAG	ANG	MAG	ANG	MAG	ANG	MAG	ANG		
0.10	0.961	-13.74	3.109	167.68	0.025	81.01	0.992	-5.18	0.09	21.01
0.20	0.936	-25.96	3.034	158.68	0.048	73.40	0.973	-10.17	0.12	18.03
0.40	0.866	-51.02	2.803	140.07	0.085	58.87	0.915	-18.43	0.23	15.20
0.60	0.784	-72.59	2.512	124.70	0.108	47.90	0.854	-24.40	0.33	13.65
0.80	0.709	-90.73	2.212	112.14	0.121	40.02	0.803	-28.70	0.45	12.61
1.00	0.652	-106.09	1.938	102.04	0.127	34.59	0.767	-31.93	0.56	11.83
1.20	0.609	-119.38	1.731	93.28	0.128	31.16	0.736	-34.55	0.70	11.31
1.40	0.578	-131.20	1.553	85.91	0.127	29.20	0.717	-36.80	0.83	10.88
1.60	0.556	-141.82	1.408	79.52	0.123	28.96	0.701	-38.74	0.97	10.59
1.80	0.540	-151.78	1.289	73.82	0.119	29.44	0.694	-40.60	1.11	8.33
2.00	0.528	-161.28	1.188	68.51	0.115	32.25	0.684	-42.21	1.28	7.00
2.20	0.519	-170.30	1.105	63.86	0.111	35.73	0.680	-43.79	1.42	6.13
2.40	0.512	-179.05	1.037	59.43	0.110	41.40	0.670	-45.38	1.56	5.34
2.60	0.508	172.23	0.970	55.60	0.110	47.08	0.668	-46.67	1.66	4.70
2.80	0.505	163.81	0.915	51.86	0.114	53.76	0.664	-48.22	1.71	4.12
3.00	0.506	155.42	0.868	48.52	0.121	59.74	0.658	-49.36	1.72	3.60

Note:

1. Gain Calculation:

$$MAG = \frac{|S_{21}|}{|S_{12}|} (K \pm \sqrt{K^2 - 1})$$

When K ≤ 1, MAG is undefined and MSG values are used. $MSG = \frac{|S_{21}|}{|S_{12}|}$, $K = \frac{1 + |\Delta|^2 - |S_{11}|^2 - |S_{22}|^2}{2 |S_{12}| |S_{21}|}$, $\Delta = S_{11} S_{22} - S_{21} S_{12}$

MAG = Maximum Available Gain

MSG = Maximum Stable Gain

TYPICAL SCATTERING PARAMETERS (T_A = 25°C)

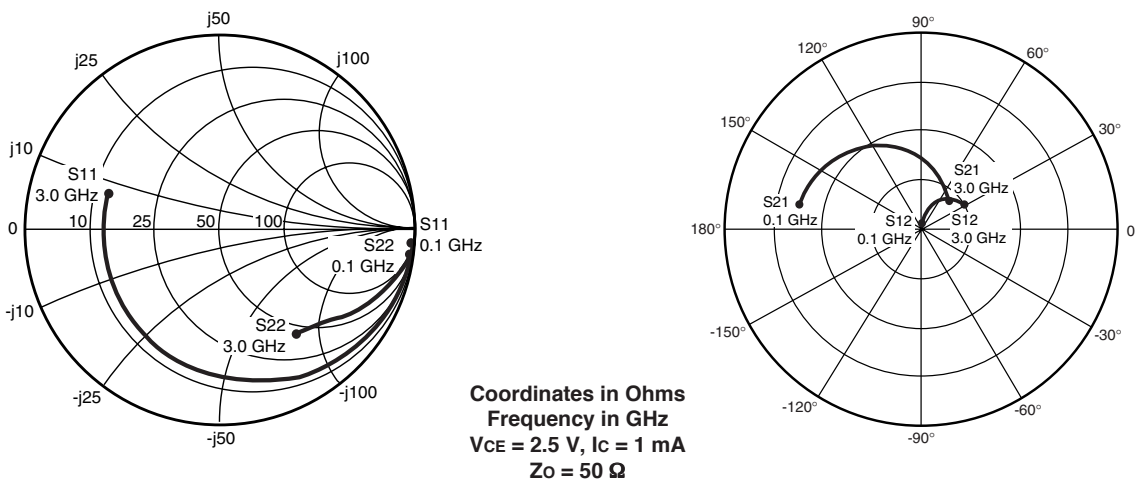

UPA802T(Q2)

V_{CE} = 2.5 V, I_C = 1 mA

FREQUENCY (GHz)	S ₁₁		S ₂₁		S ₁₂		S ₂₂		K	G _{mag} (dB)
	MAG	ANG	MAG	ANG	MAG	ANG	MAG	ANG		
0.10	0.960	-12.87	3.120	168.01	0.023	81.72	0.993	-4.73	0.09	21.39
0.20	0.939	-25.48	3.052	159.33	0.044	73.80	0.976	-9.36	0.12	18.40
0.40	0.873	-50.50	2.847	140.93	0.079	59.29	0.922	-17.18	0.22	15.55
0.60	0.793	-72.66	2.579	125.40	0.103	47.91	0.862	-23.00	0.33	14.00
0.80	0.719	-91.93	2.290	112.39	0.116	39.33	0.809	-27.36	0.44	12.96
1.00	0.664	-108.57	2.015	101.75	0.122	33.12	0.769	-30.79	0.55	12.17
1.20	0.624	-123.04	1.803	92.38	0.124	28.81	0.734	-33.73	0.68	11.64
1.40	0.598	-135.77	1.616	84.42	0.123	25.96	0.711	-36.46	0.81	11.20
1.60	0.582	-146.93	1.460	77.51	0.119	24.89	0.691	-38.85	0.96	10.90
1.80	0.574	-156.82	1.331	71.33	0.115	24.36	0.682	-41.54	1.09	8.83
2.00	0.570	-165.76	1.222	65.61	0.110	26.19	0.669	-44.01	1.26	7.41
2.20	0.570	-173.69	1.129	60.65	0.106	28.67	0.663	-46.54	1.41	6.49
2.40	0.569	179.04	1.055	55.96	0.102	33.64	0.649	-48.97	1.59	5.63
2.60	0.570	172.27	0.985	51.94	0.101	39.03	0.648	-51.47	1.70	5.02
2.80	0.569	166.04	0.927	48.02	0.103	45.91	0.641	-53.98	1.79	4.40
3.00	0.569	160.07	0.878	44.54	0.107	52.65	0.634	-56.30	1.83	3.85

Note:

1. Gain Calculation:

$$MAG = \frac{|S_{21}|}{|S_{12}|} \left(K \pm \sqrt{K^2 - 1} \right). \text{ When } K \leq 1, \text{ MAG is undefined and MSG values are used. } MSG = \frac{|S_{21}|}{|S_{12}|}, K = \frac{1 + |\Delta|^2 - |S_{11}|^2 - |S_{22}|^2}{2 |S_{12}| |S_{21}|}, \Delta = S_{11} S_{22} - S_{21} S_{12}$$

MAG = Maximum Available Gain

MSG = Maximum Stable Gain

UPA802T

TYPICAL SCATTERING PARAMETERS (T_A = 25°C)

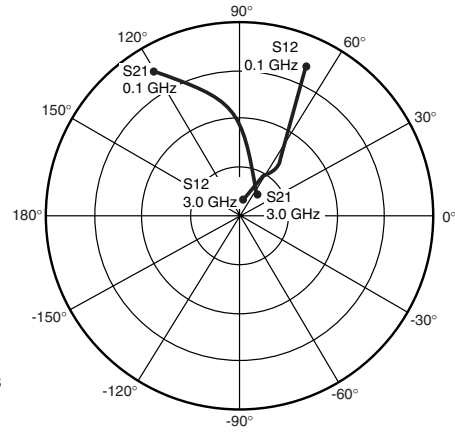
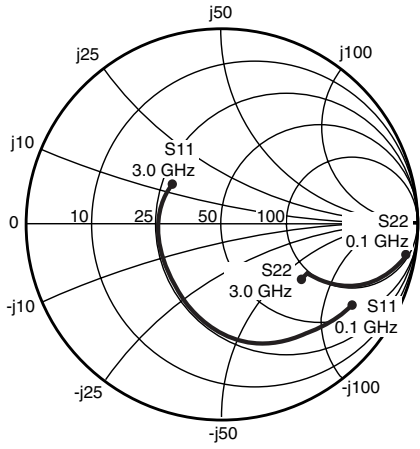

Coordinates in Ohms
Frequency in GHz
V_{CE} = 5 V, I_c = 5 mA
Z₀ = 50 Ω

UPA802T(Q1)

V_{CE} = 5 V, I_c = 5 mA

FREQUENCY (GHz)	S ₁₁		S ₂₁		S ₁₂		S ₂₂		K	Gmag (dB)
	MAG	ANG	MAG	ANG	MAG	ANG	MAG	ANG		
0.10	0.824	-25.25	13.043	159.74	0.019	76.03	0.956	-11.30	0.15	28.42
0.20	0.738	-47.27	11.730	143.72	0.033	65.58	0.867	-19.95	0.27	25.47
0.40	0.566	-83.01	8.848	120.53	0.050	54.81	0.704	-28.18	0.50	22.47
0.60	0.457	-107.67	6.700	106.46	0.060	52.18	0.610	-30.60	0.70	20.51
0.80	0.395	-125.58	5.286	97.09	0.067	52.99	0.561	-31.32	0.86	18.97
1.00	0.358	-139.68	4.336	90.05	0.074	55.02	0.536	-31.84	0.99	17.66
1.20	0.335	-151.26	3.675	84.25	0.082	57.29	0.522	-32.43	1.08	14.80
1.40	0.318	-161.37	3.186	79.25	0.090	59.48	0.516	-33.24	1.14	13.17
1.60	0.309	-170.29	2.819	74.86	0.099	61.60	0.513	-33.99	1.19	11.94
1.80	0.300	-178.64	2.525	70.74	0.108	63.26	0.513	-34.99	1.22	10.89
2.00	0.294	173.52	2.291	66.94	0.117	64.82	0.514	-35.94	1.23	10.00
2.20	0.290	166.20	2.100	63.40	0.128	65.97	0.516	-36.91	1.24	9.23
2.40	0.288	159.02	1.942	59.98	0.138	67.03	0.516	-38.01	1.24	8.52
2.60	0.289	151.93	1.804	56.88	0.149	67.72	0.516	-38.86	1.24	7.89
2.80	0.290	145.02	1.689	53.83	0.160	68.34	0.516	-39.93	1.23	7.33
3.00	0.295	138.35	1.587	50.95	0.172	68.64	0.514	-40.64	1.23	6.78

Note:

1. Gain Calculation:

$$MAG = \frac{|S_{21}|}{|S_{12}|} \left(K \pm \sqrt{K^2 - 1} \right). \text{ When } K \leq 1, \text{ MAG is undefined and MSG values are used. } MSG = \frac{|S_{21}|}{|S_{12}|}, K = \frac{1 + |\Delta|^2 - |S_{11}|^2 - |S_{22}|^2}{2 |S_{12}| |S_{21}|}, \Delta = S_{11} S_{22} - S_{21} S_{12}$$

MAG = Maximum Available Gain

MSG = Maximum Stable Gain

TYPICAL SCATTERING PARAMETERS (T_A = 25°C)

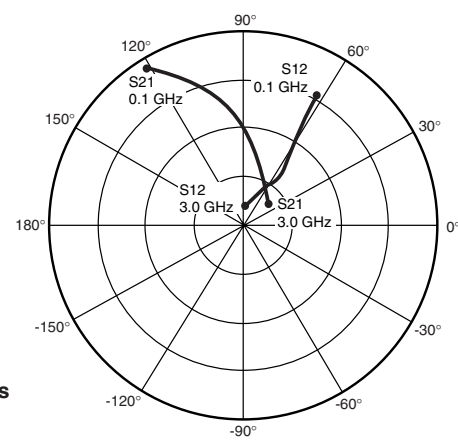
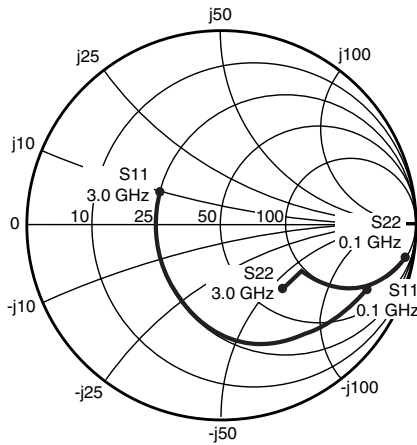

Coordinates in Ohms
Frequency in GHz
V_{CE} = 5 V, I_c = 5 mA
Z₀ = 50 Ω

UPA802T(Q2)
V_{CE} = 5 V, I_c = 5 mA

FREQUENCY (GHz)	S ₁₁		S ₂₁		S ₁₂		S ₂₂		K	Gmag (dB)
	MAG	ANG	MAG	ANG	MAG	ANG	MAG	ANG		
0.10	0.823	-24.36	13.414	160.23	0.017	76.18	0.959	-10.44	0.15	28.98
0.20	0.743	-46.52	12.139	144.45	0.030	65.94	0.877	-18.55	0.26	26.02
0.40	0.575	-82.78	9.280	121.05	0.046	54.57	0.717	-26.47	0.49	23.03
0.60	0.467	-108.62	7.075	106.49	0.055	51.23	0.621	-28.79	0.69	21.10
0.80	0.408	-127.86	5.599	96.62	0.062	51.37	0.568	-29.56	0.85	19.57
1.00	0.377	-143.07	4.595	89.14	0.068	52.88	0.537	-30.23	0.98	18.27
1.20	0.362	-155.37	3.896	82.94	0.075	54.71	0.518	-31.06	1.08	15.41
1.40	0.354	-165.68	3.376	77.52	0.082	56.53	0.506	-32.27	1.15	13.76
1.60	0.352	-174.22	2.977	72.75	0.090	58.55	0.497	-33.34	1.20	12.47
1.80	0.353	178.37	2.666	68.30	0.098	59.82	0.492	-35.02	1.23	11.45
2.00	0.356	171.97	2.416	64.18	0.107	61.15	0.488	-36.66	1.25	10.54
2.20	0.358	166.50	2.210	60.30	0.115	62.13	0.485	-38.36	1.26	9.75
2.40	0.360	161.52	2.038	56.62	0.125	63.09	0.480	-40.00	1.27	9.00
2.60	0.363	157.00	1.893	53.22	0.135	63.71	0.479	-41.73	1.27	8.38
2.80	0.364	152.78	1.770	49.89	0.145	64.24	0.477	-43.44	1.26	7.79
3.00	0.364	148.84	1.663	46.72	0.156	64.58	0.473	-44.93	1.26	7.23

Note:

1. Gain Calculation:

$$MAG = \frac{|S_{21}|}{|S_{12}|} (K \pm \sqrt{K^2 - 1})$$

When K ≤ 1, MAG is undefined and MSG values are used. $MSG = \frac{|S_{21}|}{|S_{12}|}$, $K = \frac{1 + |\Delta|^2 - |S_{11}|^2 - |S_{22}|^2}{2 |S_{12}| |S_{21}|}$, $\Delta = S_{11} S_{22} - S_{21} S_{12}$

MAG = Maximum Available Gain

MSG = Maximum Stable Gain

ORDERING INFORMATION

PART NUMBER	QUANTITY	PACKAGING
UPA802T-T1-A	3000	Tape & Reel

Life Support Applications

These NEC products are not intended for use in life support devices, appliances, or systems where the malfunction of these products can reasonably be expected to result in personal injury. The customers of CEL using or selling these products for use in such applications do so at their own risk and agree to fully indemnify CEL for all damages resulting from such improper use or sale.

EXCLUSIVE NORTH AMERICAN AGENT FOR **NEC** RF, MICROWAVE & OPTOELECTRONIC SEMICONDUCTORS

CEL CALIFORNIA EASTERN LABORATORIES • Headquarters • 4590 Patrick Henry Drive • Santa Clara, CA 95054-1817 • (408) 988-3500 • Telex 34-6393 • FAX (408) 988-0279

24-Hour Fax-On-Demand: 800-390-3232 (U.S. and Canada only) • Internet: <http://WWW.CEL.COM>

DATA SUBJECT TO CHANGE WITHOUT NOTICE

PRINTED IN USA ON RECYCLED PAPER -12/98

Subject: Compliance with EU Directives

CEL certifies, to its knowledge, that semiconductor and laser products detailed below are compliant with the requirements of European Union (EU) Directive 2002/95/EC Restriction on Use of Hazardous Substances in electrical and electronic equipment (RoHS) and the requirements of EU Directive 2003/11/EC Restriction on Penta and Octa BDE.

CEL Pb-free products have the same base part number with a suffix added. The suffix –A indicates that the device is Pb-free. The –AZ suffix is used to designate devices containing Pb which are exempted from the requirement of RoHS directive (*). In all cases the devices have Pb-free terminals. All devices with these suffixes meet the requirements of the RoHS directive.

This status is based on CEL’s understanding of the EU Directives and knowledge of the materials that go into its products as of the date of disclosure of this information.

Restricted Substance per RoHS	Concentration Limit per RoHS (values are not yet fixed)	Concentration contained in CEL devices	
		-A	-AZ
Lead (Pb)	< 1000 PPM	Not Detected	(*)
Mercury	< 1000 PPM	Not Detected	
Cadmium	< 100 PPM	Not Detected	
Hexavalent Chromium	< 1000 PPM	Not Detected	
PBB	< 1000 PPM	Not Detected	
PBDE	< 1000 PPM	Not Detected	

If you should have any additional questions regarding our devices and compliance to environmental standards, please do not hesitate to contact your local representative.

Important Information and Disclaimer: Information provided by CEL on its website or in other communications concerning the substance content of its products represents knowledge and belief as of the date that it is provided. CEL bases its knowledge and belief on information provided by third parties and makes no representation or warranty as to the accuracy of such information. Efforts are underway to better integrate information from third parties. CEL has taken and continues to take reasonable steps to provide representative and accurate information but may not have conducted destructive testing or chemical analysis on incoming materials and chemicals. CEL and CEL suppliers consider certain information to be proprietary, and thus CAS numbers and other limited information may not be available for release.

In no event shall CEL’s liability arising out of such information exceed the total purchase price of the CEL part(s) at issue sold by CEL to customer on an annual basis.

See CEL Terms and Conditions for additional clarification of warranties and liability.